

MCRP 3-11.1A

---

# Commander's Tactical Handbook

---



---

**U.S. Marine Corps**

DISTRIBUTION STATEMENT A: approved for public release; distribution is unlimited

PCN 144 000042 00

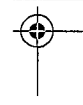
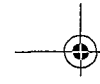

MCCDC (C 42)

17 NOV 1998

ERRATA

to

MCRP 3-11.1A

COMMANDER'S TACTICAL HANDBOOK

1. Change cover, line 6, "PCN 142 000042 00" to read: "PCN 144 000042 00."
2. Change page i, line 4, "30 July 1988" to read: "30 July 1998."
3. Change page ii, line 21, "DISTRIBUTION: 142 000042 00" to read: "DISTRIBUTION: 144 000042 00."

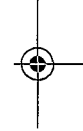

PCN 144 000042 80

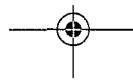

DEPARTMENT OF THE NAVY  
Headquarters United States Marine Corps  
Washington, D.C. 20380-1775

30 July 1988

FOREWORD

Marine Corps Reference Publication (MCRP) 3-11.1A, *Commander's Tactical Handbook*, contains reference material frequently used to organize, plan, and conduct Marine ground combat operations. Its intent is to assist small unit leaders functioning at the company level and below, but it also serves as a field reference guide for all Marine leaders. Leaders of combat support and combat service support organizations should familiarize themselves with the contents of this publication to understand the operational support requirements discussed. When applying the information contained in this publication, leaders must remember to—

- | Make their orders concise, clear, and simple.
- | Give subordinates a thorough understanding of the intent.
- | Explain the mission and the immediate commander's concept of operations.
- | Give subordinates their mission (task[s] and unifying purpose).
- | Integrate subordinate elements in coordinated action.
- | Allow subordinates freedom of action consistent with the need for coordination. Do not issue detailed instructions covering every possible contingency.

1. Conduct a complete estimate of each situation and develop a plan that supports success. Do not narrow the scope to only the information presented in this publication. Remember, the information presented in this publication is only a guide.

MCRP 3-11.1A is intended to be a handy compilation of important tactical information presented in loose-leaf format to better facilitate its use. It is based on information contained in numerous Marine Corps doctrinal publications. However, MCRP 3-11.1A does not supersede or replace a doctrinal publication. For detailed explanations on the tactics, techniques, and procedures found in this publication, see Marine Corps Warfighting Publication (MCWP) 3-11.1, *Marine Rifle Company* (under development), or the appropriate warfighting publication.

Reviewed and approved this date.

BY DIRECTION OF THE COMMANDANT OF THE MARINE CORPS



J. E. RHODES

Lieutenant General, U.S. Marine Corps  
Commanding General  
Marine Corps Combat Development Command

DISTRIBUTION: 142 000042 00

# COMMANDER'S TACTICAL HANDBOOK

## Table of Contents

TROOP LEADING STEPS .....	1
FIVE-PARAGRAPH ORDER FORMAT FOR COMPANY-LEVEL OPERATIONS .....	5

---

### PART I. MANEUVER

---

OFFENSIVE OPERATIONS .....	9
Attack Order General Coordinating Instructions.....	9
Movement to Contact.....	11
Attack of a Fortified Position.....	15
Mechanized Attack .....	19
Night Attack .....	23
Helicopterborne Operations .....	27
Military Operations on Urbanized Terrain .....	33
Fundamentals of Securing a Room .....	37
Amphibious Helicopterborne Assault .....	39
Amphibious Surface Assault.....	41

<b>DEFENSIVE OPERATIONS</b> .....	43
General Information .....	43
General Coordinating Instructions for Defense Orders .....	51
Reserve Considerations .....	53
Counterattack Considerations .....	55
Defensive Military Operations on Urbanized Terrain .....	57
Countermechanized Operations .....	59
Engagement Areas .....	63
Conducting Reconnaissance to Define and Build an Engagement Area .....	69
Retrograde Operations: Delay .....	73
Retrograde Operations: Withdrawal .....	77
Retrograde Operations: Retirement .....	81
Rear Area Security .....	83
<b>MILITARY OPERATIONS OTHER THAN WAR</b> .....	89
Counterinsurgency Operations .....	89
Noncombatant Evacuation Operations .....	93
Crowd and Mob Control .....	103
Cordon and Search Operations .....	107

<b>SPECIFIC TACTICAL OPERATIONS</b> .....	111
Relief in Place: Relieving Unit .....	111
Relief in Place: Unit to be Relieved .....	115
Passage of Lines: Passing Unit .....	117
Passage of Lines: Stationary Unit .....	119
Linkup Operations .....	121
Infiltration .....	123
Convoy Operations .....	127
 <b>PATROLLING</b> .....	 131
Patrol Steps .....	131
Patrol Order Information .....	135
Ambush Patrol .....	139
Urban Patrolling .....	143
Urban Patrol Tips .....	147

---

## **PART II. FIRE SUPPORT**

---

<b>GENERAL FIRE SUPPORT</b> .....	153
General Information .....	153
Company Fire Support Planning .....	157

Suggested Fire Support Coordinator	
Standing Operating Procedure .....	161
Fire Support Techniques .....	163
Company Fire Support Board .....	167
<b>QUICK FIRE SUPPORT PLAN .....</b>	<b>169</b>
<b>CALL FOR FIRE ELEMENTS .....</b>	<b>171</b>
<b>CALL FOR FIRE PROCEDURES .....</b>	<b>175</b>
<b>CALL FOR FIRE FORMAT CARD .....</b>	<b>183</b>
<b>CLOSE AIR SUPPORT .....</b>	<b>185</b>
Close Air Support Control Procedures .....	185
Close Air Support Briefing Form .....	189
<b>Appendix A. Machine Gun Employment .....</b>	<b>A-1</b>
<b>Appendix B. Weapons Handling .....</b>	<b>B-1</b>
<b>Appendix C. Nuclear, Biological, and     Chemical Defense .....</b>	<b>C-1</b>
<b>Appendix D. Communications and     Information Systems .....</b>	<b>D-1</b>
<b>Appendix E. Landing Zone Brief and Markings .....</b>	<b>E-1</b>



<b>Appendix F. Sample Fire Plan Sketches .....</b>	<b>F-1</b>
<b>Appendix G. Roadblocks and Searches .....</b>	<b>G-1</b>
<b>Appendix H. Enemy Prisoners of War .....</b>	<b>H-1</b>
<b>Appendix I. Patrol Coordination .....</b>	<b>I-1</b>
<b>Appendix J. Example Patrol Overlay .....</b>	<b>J-1</b>
<b>Appendix K. Close Air Support Aircraft Capabilities and Munitions .....</b>	<b>K-1</b>
<b>Appendix L. Weapons Capabilities .....</b>	<b>L-1</b>
<b>Appendix M. Common Threat Weapon Characteristics .....</b>	<b>M-1</b>
<b>Appendix N. Antiterrorism Procedures .....</b>	<b>N-1</b>
<b>Appendix O. Common Military Symbology .....</b>	<b>O-1</b>
<b>Appendix P. Common Tactical Terms, Definitions, and Symbols .....</b>	<b>P-1</b>
<b>Appendix Q. Metric Conversion Charts .....</b>	<b>Q-1</b>
<b>Appendix R. Glossary .....</b>	<b>R-1</b>

# TROOP-LEADING STEPS

## 1. Begin Planning.

- a. Plan the use of available time.
- b. Estimate the situation based on mission, enemy, terrain and weather, troops and support available-time available (METT-T).

(1) Mission. The mission must identify—

- | Task assigned.
- | Who, what, where, and when.
- | Commander's intent (why).

(2) Enemy. Commanders—

- | Estimate the enemy's composition and disposition based on size, activity, location, unit, time, and equipment (SALUTE), and strength.
- | Estimate the enemy's capabilities and limitations to defend, reinforce, attack, withdraw, and delay (DRAW-D).
- | Estimate the enemy's most probable course of action.
- | Identify vulnerabilities that can be exploited.

- (3) Terrain and weather are evaluated based on key terrain, observation and fields of fire, cover and concealment, obstacles, avenues of approach, and weather/astrological data (KOCOAW).
  - (4) Troops and support available are evaluated based on the following:
    - ┆ People.
    - ┆ Human factors.
    - ┆ Equipment.
    - ┆ Logistics.
    - ┆ Fire support.
    - ┆ Space.
  - (5) Available time. Commanders use the following to plan available time:
    - ┆ 1/3 - 2/3 rule (allocate 2/3 of available time for subordinates).
    - ┆ Backward planning.
    - ┆ Parallel and concurrent planning.
- c. Issue warning order.

## **2. Arrange.**

- a. Movement of unit (where, when, and how).
- b. Reconnaissance.

- (1) Select route, personnel, and use of subordinates.
  - (2) Determine method (e.g., route, aerial, map, vantage point).
- c. Issue of order (notify subordinate leaders of time and place).
  - d. Coordination (adjacent and supporting units).

### **3. Make Reconnaissance.**

- a. Update METT-T.
- b. Develop enemy's most probable course of action.
- c. Confirm enemy's vulnerabilities.

### **4. Complete Plan.**

- a. Remember the concept of operations is driven by METT-T with an emphasis on mission (including intent) and the enemy's most probable course of action.
- b. Develop scheme of maneuver to exploit enemy's vulnerability by placing him in a dilemma.

### **5. Issue Order.**

Use the Five-Paragraph Order Format on page 5 (address the vantage point, use terrain modeling, use overlays, etc., if applicable).

### **6. Supervise.**

Use brief backs, rehearsals, inspections, etc.

# FIVE-PARAGRAPH ORDER FORMAT FOR COMPANY-LEVEL OPERATIONS

A map and/or terrain model orientation is normally given prior to issuing the order.

## 1. Situation.

- a. Friendly forces.
  - (1) Higher unit mission (task and commander's intent).
  - (2) Adjacent unit missions (task and intent).
    - (a) Left.
    - (b) Front.
    - (c) Right.
    - (d) Rear.
  - (3) Supporting unit missions (task and intent).
- b. Enemy forces.
  - (1) Composition, disposition, and strength is based on size, activity, location, unit, time, and equipment (SA-LUTE).
  - (2) Capabilities and limitations to defend, reinforce, attack, withdraw, and delay (DRAW-D).
  - (3) Enemy's most probable course of action.
- c. Attachments and detachments (date and time effective).

## **2. Mission.**

Task to be accomplished and purpose (who, what, when, where, and why).

## **3. Execution.**

- a. Commander's intent and concept of operations.
  - (1) Commander's intent.
  - (2) Concept of operations (scheme of maneuver and fire support plan).
- b. Subordinate element missions (main effort, supporting efforts, and reserve).
- c. Coordinating instructions (identify and discuss instructions that are common to two or more elements).

## **4. Administration and Logistics.**

- a. Administration.
- b. Logistics (beans, bullets, bandages, bad guys, and batteries).

## **5. Command and Signal.**

- a. Signal.
- b. Command.
  - (1) Location of key leaders.
  - (2) Chain of command (command succession).

*Any questions? The time is now*\_\_\_\_\_.

# PART I

# MANEUVER

*“In tactics, the most important thing is not whether you go left or right, but why you go left or right.”*

General A. M. Gray  
(MCDP 1-3, *Tactics*, p.1)



Property of the U.S. Marine Corps

Marines move out to take Japanese position.  
(Tarawa, November 1943)

# OFFENSIVE OPERATIONS

---

## **Attack Order General Coordinating Instructions**

---

The following list identifies kinds of coordinating instructions that are common to two or more elements:

- | Order of movement/formations for movement.
- | Consolidation instructions: security, automatic weapons (see app. A), fields of fire, entrench (SAFE), and other measures.
- | Displacement. Displacement instructions need to address—
  - Method.
  - Objective.
  - Route.
  - Time.
- | Time of attack (crossing the line of departure).
- | Main effort.
- | Base unit.
- | Tactical control measures (e.g., line of departure, assault position).
- | Report of crossing phase line.
- | Report of arrival at checkpoints.



- | Actions upon contact. (See app. B.)
- | Report of enemy activity immediately to commander.
- | Preparations to continue the attack.
- | Mission-oriented protective posture (MOPP) levels 0, 1, 2, 3, and 4. (See app. C.)
- | Sleep plan.
- | Rehearsal plan for the most critical to the least critical events and actions.
- | Bump plan.
- | Rules of engagement.
- | Linkup plans.
- | Other (as required).
- | Timeline.

---

# Movement to Contact

---

## 1. Contact Possibility.

- a. Contact remote.
- b. Contact possible/probable.
- c. Contact imminent.

## 2. Formation.

- a. Route column.
- b. Tactical column.

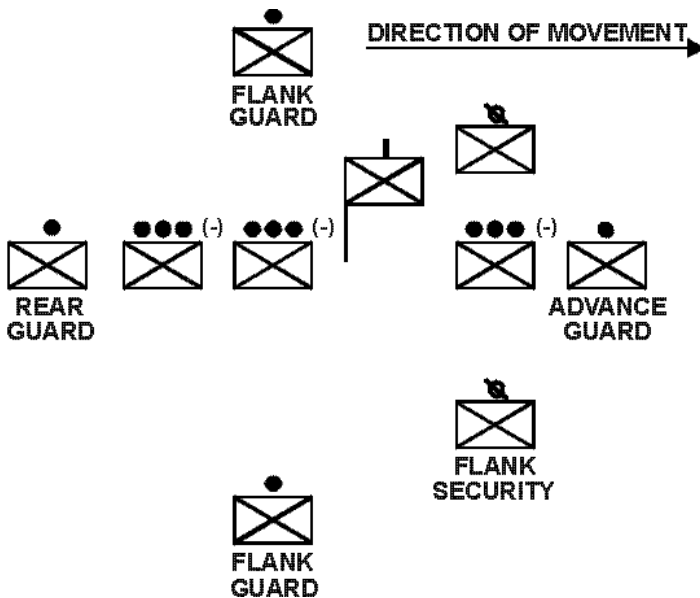

- c. Approach march.

### **3. Movement Considerations.**

- a. Speed characterizes bold and aggressive action.
- b. Security all around provides early warning (bump technique).
- c. Flexibility and ease of control are consistent with expectation of enemy contact (leapfrog technique).
- d. Use of connecting files.
- e. Initial contact with the smallest unit; develop the situation.

### **4. Movement Techniques.**

- a. Traveling is used when—
  - | Speed is essential.
  - | Movement is easy to control.
  - | Enemy threat is remote.
- b. Traveling overwatch is used when—
  - | Speed and security are equal.
  - | Movement is harder to control.
  - | Enemy threat is possible/probable.
- c. Bounding overwatch is used when—
  - | Security is essential.
  - | Movement is hardest to control.
  - | Enemy threat is imminent.

## **5. Common Control Measures.**

- a. March objective.
- b. Axis of advance or zone of action.
- c. Phase lines.
- d. Checkpoints.
- e. Contact points.
- f. Boundaries.

## **6. Combined-Arms Usage.**

- a. Designate planned, on-call targets for immediate suppression and for shifting during movement.
- b. Use priority targets that can be activated/deactivated on order or by event.
- c. Plan for flexible positioning of crew-served weapons within formation.

## **7. Miscellaneous.**

- a. Plan for all-purpose lightweight individual carrying equipment (ALICE) pack drop and retrieval during dismounted operations.
- b. Plan and conduct extensive rehearsals (emphasis on immediate action drills/contact).
- c. Plan communications with the point element and ensure that the signal plan facilitates action drills. (See app. D.)

---

# Attack of a Fortified Position

---

## 1. Principles.

- a. Suppress enemy observation points and frontline units.
- b. Obscure enemy with smoke concentration.
- c. Secure breach point and initial positions.
- d. Reduce frontline positions, roll flanks, and rear areas.

## 2. Planning Considerations.

- a. Provide a thorough intelligence brief on the enemy's location and capabilities.
- b. Plan carefully when developing scheme of maneuver and fire support plan.
- c. Plan aggressive individual and small-unit actions.
- d. Plan effective control and coordination down to the lowest level.
- e. Understand the scheme of maneuver and principles involved in the attack of a fortified position.
- f. Consider conducting a clandestine breach.

## 3. Breaching Task Organization/Tasks.

- a. Support elements may be located in multiple positions and—
  - 1 Support all phases of attack with fire.
  - 1 Cover, initially, a large part of the objective by fire.
  - 1 Concentrate fires in a narrow sector to allow assault/breach element to seize initial enemy position.

- b. Assault/breach element is an obstacle-clearing detachment that is made up of an infantry squad or platoon and an engineering detachment. It is normally the smallest element. It—
  - ┆ Breaches any obstacle in the path of an attacking unit.
  - ┆ Creates and defends the initial gap or opening in the enemy's defense.
  - ┆ Considers multiple or false breaches.
- c. Penetration/exploitation element is the largest reinforced element. It—
  - ┆ Widens penetration of the enemy's position.
  - ┆ Continues the attack into the enemy's secondary defenses and rear areas.
  - ┆ Occupies key terrain (e.g., trench intersections, key bunkers).

*Note: A unit can be assigned the mission of more than one element.*

#### **4. Special Equipment.**

- a. Demolitions (e.g., satchel charges, line charges, bangalore torpedoes).
- b. Mine detectors, wire cutters, and grappling hooks.
- c. Large quantities of rockets, hand grenades, and machine gun ammunition.
- d. Flags to mark forward progress.
- e. Flares/material to mark breach lanes.

## **5. Coordinating Instructions.**

- a. Method of marking cleared bunkers/trenches.
- b. Reduction sequence and plan for destruction of bunkers.

## **6. Clearing Teams (fire team organization).**

- a. No. 1 is an automatic rifleman who suppresses each leg of the trench after No. 2 throws the grenade.
- b. No. 2 assists the automatic rifleman by throwing the grenade and acting as a cover for No. 1.
- c. No. 3 is a team leader who controls the team's clearing procedures and indirect suppressive fires.
- d. No. 4 is a rifleman who provides rear security.

---

# Mechanized Attack

---

## 1. Principles of Mechanized Operations.

- a. Concentration.
- b. Surprise.
- c. Speed.
- d. Flexibility.
- e. Boldness.

## 2. Task Organization.

- a. Assault element.
- b. Support element.
- c. Breach element.

## 3. Order of Movement.

- a. Tanks lead in open areas or when faced with significant armor threat.
- b. Mounted infantry leads are only used if mechanized infantry is pure with no other antiarmor reinforcements or capabilities.
- c. Dismounted infantry leads when—
  - 1 Terrain and vegetation are restrictive.
  - 1 Visibility is poor.
  - 1 Antitank guided missiles are a threat.
  - 1 Significant obstacles or fortified positions are encountered.



#### **4. Movement Techniques.**

- a. Traveling technique is used when—
  - | Speed is essential.
  - | Movement is easy to control.
  - | Threat of enemy contact is remote.
- b. Traveling overwatch is used when—
  - | Speed and security are equal.
  - | Movement is harder to control.
  - | Threat of enemy contact is possible/probable (bump technique).
- c. Bounding overwatch is used when—
  - | Security is essential.
  - | Movement is hardest to control.
  - | Threat of enemy contact is imminent (leapfrog technique).

#### **5. Combined-Arms.**

- a. Designate planned, on-call targets for immediate suppression and for shifting during movement.
- b. Use priority target that can be activated/deactivated on order or by event.
- c. Plan for the use of smoke to obscure dismount point and/or assault position.
- d. Consider use of series targets for movement/attack.
- e. Place enemy in a dilemma.

## 6. Coordinating Instructions.

- a. Order of movement/formations for movement.
- b. Consolidation instructions: security, automatic weapon, fields of fire, entrench (SAFE), and measures.
- c. Displacement. Displacement instructions need to address—
  1. Method.
  1. Objective.
  1. Route.
  1. Time.
- d. Time of attack (crossing the line of departure).
- e. Main effort.
- f. Base unit.
- g. Tactical control measures (e.g., line of departure, assault position).
- h. Report of crossing phase line.
- i. Report of arrival at checkpoints.
- j. Actions upon contact.
- k. Report of enemy activity immediately to commander.
- l. Preparations to continue the attack.
- m. Mission-oriented protective posture (MOPP) levels 0, 1, 2, 3, and 4.
- n. Sleep plan.
- o. Rehearsal plan for the most critical to the least critical events/actions.
- p. Bump plan.
- q. Rules of engagement.

- r. Linkup plans.
- s. Other (as required).
- t. Timeline.

## **7. Additional Instructions.**

- a. Actions on contact.
  - (1) Contact from the front, rear, left, and right.
  - (2) Actions against air, artillery, ground defense, etc.
- b. Actions for hasty and in-stride breach.
  - (1) Support force.
  - (2) Breach force.
  - (3) Assault force.
- c. Alternate means of communication (e.g., hand and arm signals, pyrotechnics). Signal plan facilitates action drills.
- d. March speed/maximum catch-up.
- e. Distance between vehicles/distance between units.
- f. Security for disabled vehicles during movement and during scheduled and unscheduled halts.
- g. Technique of movement.
- h. Antitank guided missile battle drill.
  - (1) Designate priority targets.
  - (2) Plan actions upon contact.
- i. Dismount area.
- j. Fire control measures (mechanized assets supporting a dismounted attack by fire).

---

# Night Attack

---

## 1. Types.

- a. Illuminated night attack principles are the same as a daylight attack.
- b. Nonilluminated night attack uses stealth to achieve surprise.
- c. Supported or nonsupported night attacks are selected based on the degree of surprise needed.

*Note: Always plan for the use of supporting fires.*

## 2. Nonilluminated, Nonsupported, Night Attack Principles.

- a. Control (mark key leaders for easy identification).
- b. Direction (use compasses and assault azimuth).
- c. Surprise (quickly follow with bold, aggressive action).

## 3. Common Control Measures.

- a. Point of departure.
- b. Contact point.
- c. Release points.
- d. Probable line of deployment (PLD).
- e. Routes.
- f. Limit of advance.
- g. Time of attack.

#### 4. Reconnaissance—PLD Patrol.

- a. Gain detailed information on enemy and terrain.
- b. Mark routes.
- c. Provide guides for night attack force.
- d. Maintain surveillance of the area of objective.
- e. Establish PLD.

#### 5. Techniques for Loading PLD.

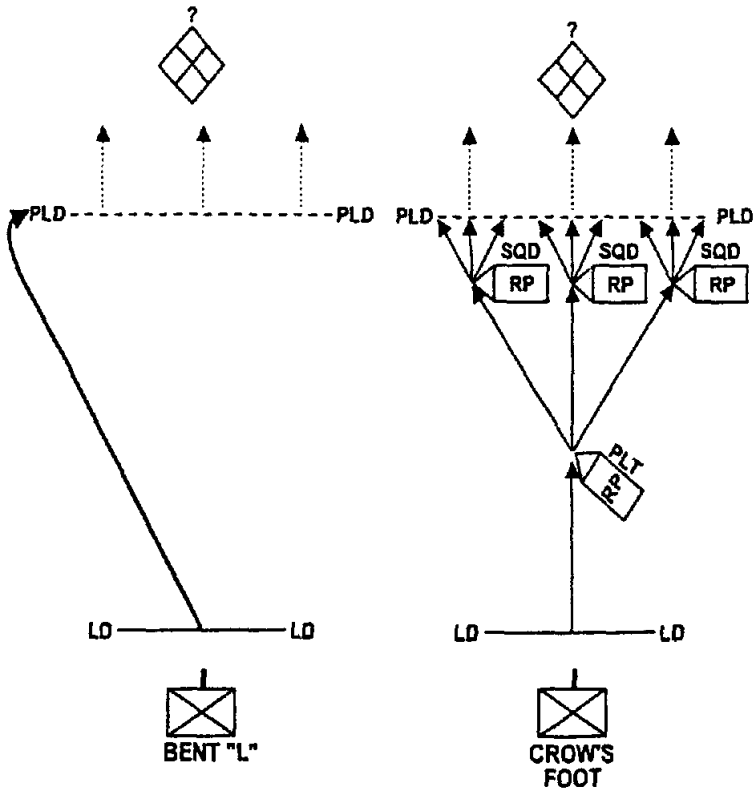

## **6. General Considerations.**

- a. All units are physically tied in on the PLD.
- b. PLD patrol is composed of Marines from each platoon.
- c. Contingency plans for enemy contact are used—
  - ┆ Prior to loading PLD.
  - ┆ During deployment onto the PLD.
  - ┆ If receiving sporadic fire from defensive lines or observation post/listening post.
- d. Obstacle breach is planned.
- e. Illumination plan is initiated on contact.



---

# Helicopterborne Operations

---

## 1. Planning Considerations.

- a. Determine the total number of aircraft available by consulting the forward air controller/air officer.
- b. Determine the number and type of aircraft allocated to each wave by consulting with the forward air controller/air officer.
- c. Determine the size of the landing zone and surrounding terrain/vegetation by using maps, photographs, reconnaissance, and intelligence reports.
- d. Determine load plan per aircraft.
  - (1) Spread loading of the key personnel, weapons, and equipment.
  - (2) Establish a bump plan in case there are aircraft complications or changes.
- e. Prepare and collect a manifest for each heliteam.
- f. Determine the need for landing zone security (both pick-up and insert).
- g. Plan for both primary and alternate landing zones. (Who has authority to change from primary to alternate?)
- h. Mark landing zone (e.g., panels, smoke, NATO inverted Y). (See app. E.)
- i. Use initial terminal guidance, if available.



## **2. Landing Considerations.**

- a. Leaders must orient themselves and the heliteam prior to the ramp going down (12 o'clock).
- b. A rifle platoon is generally the smallest tactical unit to land in one wave.
- c. The helicopterborne force lands prepared to fight in any direction.
- d. Leaders must plan for security immediately upon landing.
- e. Leaders establish unit sectors based on the clock method or key terrain objectives.
- f. Leaders establish procedures/signals to prepare, load, orient, etc., upon landing.
- g. Leaders designate guides for subsequent lifts.

## **3. Loading Considerations.**

- a. Secure a corner of a large landing zone with a part of the force (leave remainder in the assembly/holding area during embarkation and debarkation).
- b. Secure the entire perimeter of a smaller landing zone during embarkation and debarkation.
- c. Designate a pick-up zone control officer/marshalling area control officer.
- d. Instruct the heliteams to head to the release point (holding area) and drop off the manifest. If manifest cards are collected prior to helicopter arrival, units may bypass the release point and, on signal, head directly for their assigned aircraft.
- e. Extract the security unit last.

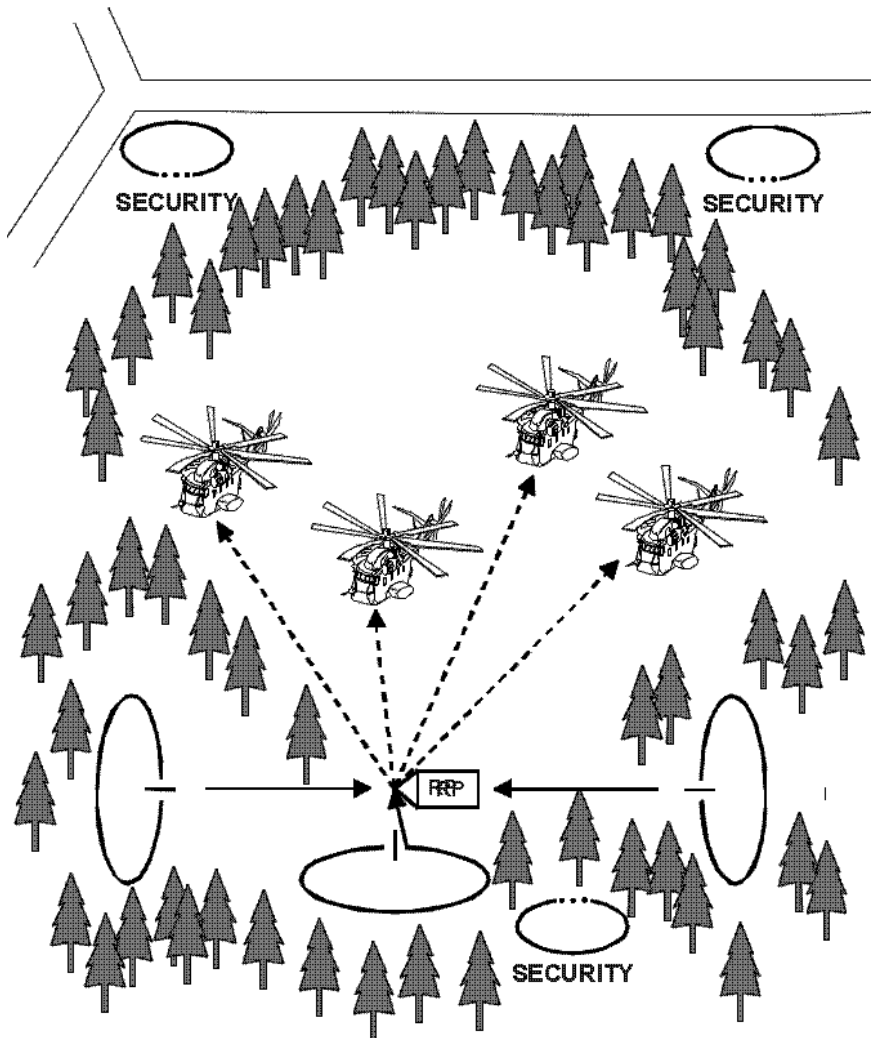

#### **4. General Considerations.**

- a. GO/NO GO criteria.
- b. Downed helicopter procedures.
- c. Evasion and escape (E&E) plan.
- d. Search and rescue (SAR) plan/combat search and rescue (CSAR) plan/tactical recovery of aircraft and personnel (TRAP) plan.
- e. Weapon carried muzzle down for CH-46s/53s and muzzle up for UH-1s.
- f. Packs slung over one shoulder can be easily ditched if required.
- g. Soft covers are removed when helicopters are inbound.
- h. The heliteam leader/senior man uses, once inside the helicopter, an internal communications system (ICS) to coordinate and confirm route, landing plan, and landing zone with the helicopter pilot.

#### **5. Common Control Measures.**

- a. Identify the marking colors of the assembly area, landing zone, pick-up zone, holding area, and landing site.
- b. Identify and designate the number of release points and landing points required.

## 6. Common Helicopter Data.

	<b>UH-1N</b>	<b>CH-46E</b>	<b>CH-53D</b>	<b>CH-53E</b>
Normal troop capacity (peacetime)	6	12	18	18
Normal troop capacity (combat)	6	15-20	30	30
Maximum troop seating capacity	12	25	37 55 <sup>1</sup>	37 55 <sup>1</sup>
Litter capacity	6	15	24	24
Classification	utility light	medium	heavy	heavy
<sup>1</sup> Up to 55 seats (center line installation). The number of passengers (PAX) may be limited during training.				

---

## **Military Operations on Urbanized Terrain**

---

### **1. Military Operations on Urbanized Terrain (MOUT) Phases of the Attack.**

- a. Reconnoiter the objective (reconnaissance and intelligence gathering to support planning).
- b. Isolate the objective (a portion or the entire urban area).
- c. Gain a foothold/establish a point of entry (rapid buildup of combat power).
- d. Attack or clear the objective.

### **2. Platoon in the Attack.**

- a. Commander's plan ensures understanding and coordination (detailed centralized planning/decentralized execution).
- b. Attack is heavily decentralized (initiative, adaptation, and small-unit leadership).
- c. Buildings are attacked as if they were fortified positions.
- d. Unit size is based on mission, enemy, terrain and weather, troops and support available-time available (METT-T).
- e. Control is maintained between adjacent units.
- f. Scheme of maneuver and fire support plan emphasize use of direct fire weapons in close support of assault.
- g. Scheme of maneuver must provide for detailed, systematic, step-by-step reduction of all objectives assigned to the platoon.

- h. Automatic weapons are assigned principal direction of fires on streets to isolate the enemy.
- i. Assault is characterized by three steps.
  - (1) Isolate.
  - (2) Gain entry.
  - (3) Clear.

### **3. Coordinating Instructions.**

- a. Use phase lines, boundaries, checkpoints, etc., to aid in control.
- b. Identify structures (and the order in which they will be attacked) by the number or letter.
- c. Specify method for marking secured buildings so they can be identified by other friendlies.
- d. Specify detailed actions of search team/cover team.
- e. Establish casualty collection points, enemy prisoner of war collection points, and refugee control point.
- f. Specify the method for marking individual Marines and entry points.

### **4. General Considerations.**

- a. Check all holes, doorways, and windows for booby traps prior to entering.
- b. Enter buildings from the top if possible.
- c. Breach/create ground floor entry by using demolition or direct fire weapons.

- d. Ensure breakdown into clearing and covering teams.
- e. Achieve fire superiority before attacking a building.
- f. Maintain the principle of all-around security (consider the three-dimensional threat).
- g. Conduct rehearsals and prepare standing operating procedures which are vital down to the smallest unit level.
- h. Designate marksmen and use them.
- i. Identify grenades by type and quantity, as well as issue safety instructions.
- j. Consider the use of riot control agents if authorized.
- k. Consider the use of smoke, backblast from weapons, etc., to cover movements across danger areas.

## **5. Organization.**

- a. Platoon level is organized into assault, support, and security forces.
  - (1) Each force is normally based around a rifle squad.
  - (2) Squads may be reinforced with crew-served weapons, forward observers, etc.
- b. Squad level is organized into an assault force and support force and reinforced or task-organized as needed based on METT-T.
  - (1) Assault force consists of one assault element, one security element, and one fire team for each element (two fire teams total).

- (2) Support force consists of one fire team (may be rotated).
- c. Fire team level, assault element is organized into two-man search and two-man cover teams.



---

# **Fundamentals of Securing a Room**

---

## **1. General Considerations.**

- a. Dominate the room and approaches.
- b. Employ speed, accuracy, violence of action, and momentum.
- c. Conduct area searches to eliminate all threats.
- d. Shoot threat targets, cover danger areas, protect each other.
- e. Report the situation.
- f. Continue attack or defend.

## **2. Basic Rules to Follow.**

- a. Follow safety rules.
- b. Know your weapon's condition.
- c. Move as fast as possible; however the ability to shoot accurately must be maintained.
- d. Lead with head and eyes.
- e. Move smoothly but quickly from covered position to covered position, remain low when stationary.
- f. Concentrate on the front sight post (eyes, muzzle, target).
- g. Follow through. Engage target until it is down.
- h. Cover assigned sectors.
- i. Maintain awareness (don't be startled).
- j. Avoid speed reloading; keep track of your remaining ammunition.
- k. Lead with physical aggression.

- l. Clear constricted spaces from the outside.
- m. Clear a corner before moving into it.
- n. Never make entry alone.
- o. Reload before all rounds are expended.
- p. Normally assign at least one squad to clear a building (use mission, enemy, terrain and weather, troops and support available-time available [METT-T]).
- q. Maintain three-dimensional security. Hallways are fatal funnels of fire.
- r. Focus on hand-carried items and hand movements of occupants to determine if weapons are present and to react to hostile intent.
- s. Communicate constantly with each other.
- t. Keep off walls (12 to 18 inches).

---

## Amphibious Helicopterborne Assault

---

The following coordinating instructions are common to two or more elements:

- | Assembly area for loading.
- | Heliteam wave and serial assignment table submitted by (time) and (location).
- | Heliteams formed by (time) and (location).
- | Tactical spread loading and bump plan.
- | Manifest submitted by (time) and (location).
- | Zone inspection, planning, preparing and operation (ZIPPO) brief at (time) and (location) given by (who) for (whom).
- | Heliteam organization.
- | Landing plan.
- | Landing zone organization (flying out).
- | Landing zone organization (flying in).
- | L-hour.
- | Portion of landing zone reported as secure.
- | 12 o' clock is \_\_\_\_\_.
- | Tentative extraction plan.

---

## Amphibious Surface Assault

---

The following coordinating instructions are common to all elements:

- | H-hour.
- | L-hour.
- | Staging areas/boat stations.
- | Boat team organization, ensuring tactical spread loading and bump plan.
- | Serial assignment tables submitted by (time) and (location).
- | Manifest submitted by (time) and (location).
- | Assault stage by (time) and (location).
- | Boat teams formed by (time) and (location).
- | Ship-to-shore movement.
- | Landing plan.
- | GO/NO GO criteria.



# DEFENSIVE OPERATIONS

---

## General Information

---

### 1. Characteristics.

- a. Preparation. Leaders post local security to provide early warning.
- b. Disruption of enemy attacks. Defensive operations aim to disrupt enemy attacks as far from friendly forces as possible.
- c. Concentration of combat power. Leaders ensure that combat power is available at decisive time and place.
- d. Flexibility. Forces maintain the ability to deal with a variety of enemy courses of action.
- e. Use of terrain. Leaders control avenues of approach based on key terrain, observation and fields of fire, cover and concealment, obstacles, and avenues of approach (KOCOAs).
- f. Security. Forces use both active and passive measures.
- g. Mutual support. Leaders position units so they can reinforce each other.
- h. Defense in depth. A shallow defense is vulnerable to a concentrated attack.
- i. Obstacle plan. A coordinated obstacle plan strengthens defensive operations.
- j. Fire plan. Leaders coordinate and integrate direct/indirect fire plans with the scheme of maneuver and obstacle plans. (See app. F.)

## **2. Reconnaissance.**

- a. Issue warning order and plan leader's reconnaissance.
  - (1) Identify the type of reconnaissance plan (e.g., map, visual, helicopter).
  - (2) Identify the number of personnel and key personnel/equipment participating in reconnaissance party.
  - (3) Identify security requirements.
  - (4) Identify leaders remaining with the company.
  - (5) Develop 5-point contingency plan.
- b. Plan reconnaissance actions.
  - (1) Develop/confirm occupation plan (e.g., crow's foot, bent L).
  - (2) Confirm/deny possible enemy avenues of approach and courses of action.
  - (3) Designate fields of fire and dead space.
  - (4) Locate listening post (LP)/observation posts (OPs).
  - (5) Designate tentative primary, alternate, and supplementary positions.
  - (6) Confirm and develop tentative obstacles and fire support plans.
  - (7) Designate tentative locations for command posts; aid stations; nuclear, biological, and chemical evacuation stations; medical evacuation station landing zone; petroleum, oils, and lubricants; and logistics.

- (8) Designate sectors of fire.
- (9) Identify adjacent unit's positions and ensure that sectors of fire are mutually supporting.
- (10) Establish security plan (OP/LP) and initial communications (wire) plan.

### **3. Final Planning Considerations.**

- a. Does the defensive plan—
  - | Allow for flexibility?
  - | Allow for proper use of terrain?
  - | Provide for mutual support?
  - | Provide adequate security measures?
  - | Provide for enough depth?
  - | Allow for planned use of reserve and/or counterattack?
- b. Have adjacent units' positions, sectors of fire, etc., been confirmed?
- c. Is defense from battle position or sector?
- d. Which type of defense is planned, linear, reverse slope, or perimeter? Which defense best accomplishes the mission and uses the terrain to best advantage?
- e. What are the positions of key weapon systems? Do they support the defensive plan? Are direct support/general support weapon systems within the position/sector efficiently secured by the infantry?



- f. Does the fire support plan—
  - ┆ Support the defensive scheme of maneuver and security (patrolling) plans?
  - ┆ Cover the use of high explosives, smoke, and illumination?
- g. Does the engineering plan—
  - ┆ Place the priority of effort on mobility, countermobility, or survivability?
  - ┆ Support the defensive scheme of maneuver and fire support plans?
  - ┆ Integrate with the engineering plan of adjacent units?
  - ┆ Provide for concealment of obstacles?
  - ┆ Provide for cover of obstacles by fire?

**4. Battle Positions Versus Sector.**

<b>Considerations</b>	<b>Battle Position</b>	<b>Sectors</b>
Avenues of approach	Well defined; enemy can be canalized	Not easily defined
Terrain	Dominates avenues of approach	Dominating terrain not available
Area of operation	Narrow/small	Wide/large
Mutual support	Achievable	Not easily achieved
Commander's ability to control	Good	Degraded

**5. Defensive Types.**

- a. Perimeter.
- b. Linear.
- c. Reverse slope.

## 6. Conduct.

- a. To prepare for combat, leaders—
  - ┆ Receive the mission.
  - ┆ Make tentative plans.
  - ┆ Issue the warning order.
- b. To prepare for reconnaissance missions, leaders—
  - ┆ Confirm the enemy's probable avenue of approach.
  - ┆ Identify dead space.
  - ┆ Identify location for OPs/LPs.
  - ┆ Identify location of primary, alternate, and supplementary positions for subunits and major weapons systems.
- c. Once reconnaissance is completed, movement into the defense begins:
  - ┆ OPs/LPs and guides may be left in position.
  - ┆ Unit leaders complete and issue orders, conduct inspections, and conduct rehearsals.
  - ┆ The company moves forward by unit or by platoon/section to occupy position.
- d. Occupation of the defense.
  - (1) Prior to entrenching, leaders—
    - ┆ Walk the defensive position to reexamine sectors of fire and to confirm the position.
    - ┆ Establish face-to-face coordination with adjacent unit leaders.

- (2) During occupation of positions, leaders—
  - | Confirm sectors and check interlocking fires and dead space.
  - | Physically check and confirm positions of key weapons.
  - | Check range cards.
  - | Complete defense fire plan sketch and deliver to the next higher command.
  - | Look at weapons, positions, and obstacles from enemy point of view.
  - | Disseminate any information received.
  - | Ensure automatic weapons are integrated and protected with infantry.
  - | Check security and alert plan, patrol plan, radio watch, and logistics.
  - | Rehearse routes to and from alternate and/or supplementary positions.
- (3) Based on mission, enemy, terrain and weather, troops and support available-time available (METT-T) and security, automatic weapon, fields of fire, entrench (SAFE), leaders—
  - | Establish location security (OP/LP) and specify levels of alert.

- | Position automatic weapons and assign their sectors to include the final protective line or principal direction of fire.
- | Identify sectors of fire for all other weapons and emplace aiming stakes.
- | Design primary positions and entrench.
- | Establish and register final protective fires (mortars and artillery) to cover dead space.
- | Clear fields of fire and begin entrenching.
- | Prepare range cards and fire plan sketches. (See app. K.)
- | Lay and bury communications wire.
- | Emplace obstacles (e.g., wire, mines, booby traps).
- | Mark target reference points (TRPs) and direct fire control measures.
- | Prepare alternate and supplementary positions.
- | Establish rest plan.
- | Rehearse engagements.
- | Stockpile ammunition, food, and water.

### 7. Reverse Slope Defense.

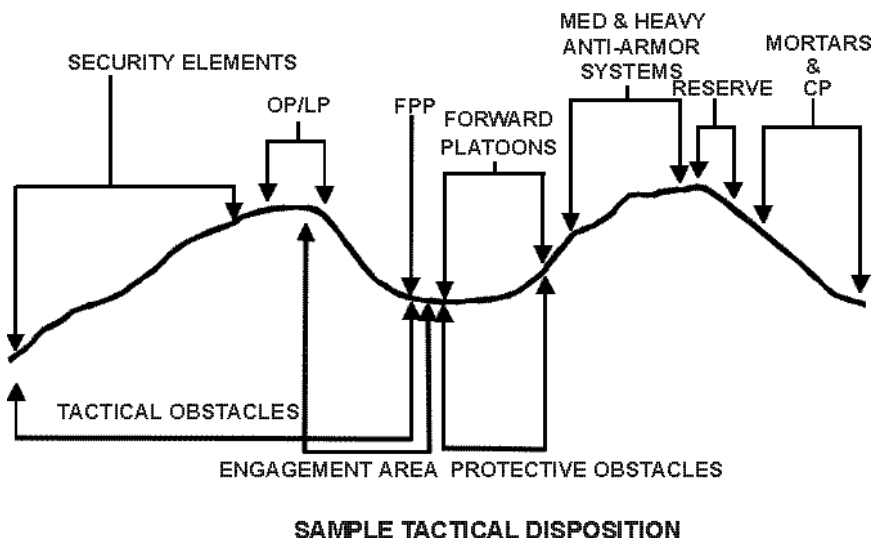
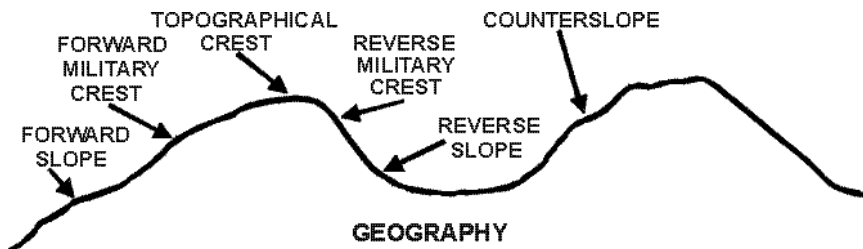

---

## General Coordinating Instructions for Defense Orders

---

The following coordinating instructions are common to two or more elements:

- | Movement into the defense (deliberate defense only).
- | Location/grids for tactical and fire control measures (e.g., boundary, sectors of fire, target reference point, engagement area).
- | Target precedence.
- | Security plan (percent alert).
- | Engagement and disengagement criteria and instructions.
- | Rates of fire.
- | Priority of work based on security, automatic weapons, fields of fire, entrench (SAFE).
- | Reporting requirements.
- | Mission-oriented protective posture (MOPP) levels 0, 1, 2, 3, and 4.
- | Control of illumination.
- | Stand-to commences (time) and ceases (time).
- | Movement within position.
- | Other.
- | Timeline.

---

# Reserve Considerations

---

## 1. General Considerations.

- a. Commit enough combat power to be decisive at the critical point.
- b. Consider that the smallest unit capable of creating a reserve is generally a company.
- c. Prioritize missions for planning purposes (be prepared).
- d. Assign positions near the most likely place of commitment.
- e. Consider locating Reserve Force commander with a higher commander for better situational awareness.

## 2. Possible Missions.

- a. Reinforce the main battle area.
- b. Add depth to the defense.
- c. Block or contain penetrations.
- d. Protect flanks and rear areas.
- e. Conduct a hasty counterattack.
- f. Support the forward element by fire.

---

# Counterattack Considerations

---

## 1. General Considerations.

- a. Enemy's strength and mobility.
- b. Initial disposition, assembly areas, coordination measures, and routes.
- c. Coordination with frontline units.
- d. Fire support plan.
- e. Communications/signals.
- f. Rehearsals.

## 2. Types.

- a. Planned counterattack—
  - | Uses a designated force (not part of the reserve).
  - | Is planned prior to battle and mission assigned to a sub-unit as an on-order mission.
  - | Is prepared, coordinated, and rehearsed in detail.
  - | Is issued as an attack plan with tentative objectives and direction of attack.
  - | Becomes the main effort once employed.
- b. Hasty counterattack—
  - | Is a defensive measure that wasn't implemented in the commander's original scheme of maneuver.
  - | Tasks the least engaged unit if a reserve is not already assigned.
  - | Is normally assigned as a be-prepared mission or issued as a fragmentary order.



---

# Defensive Military Operations on Urbanized Terrain

---

## 1. Principles.

- a. Employ all-around defense and mutually supporting positions.
- b. Establish three-dimensional security (above, below, and around).
- c. Deny enemy freedom of movement (barricade avenues of approach).

## 2. Planning.

- a. Leaders assign priorities of work in the defense based on mission, enemy, terrain and weather, troops and support available-time available (METT-T); security, automatic weapon, fields of fire, entrench (SAFE); and other considerations.
- b. Leaders plan positions to achieve defense in depth.
- c. Leaders plan and implement obstacle/barrier plan.
- d. Leaders determine the priority of buildings/areas to defend.
- e. Leaders generally assign one platoon (based on METT-T) to defend one block or one large building.

## 3. General Considerations.

- a. Position security high for best observation and survivability.
- b. Employ automatic weapons at ground level and antiaircraft at higher level for effectiveness.

- c. Anticipate the special considerations required when using weapons with back blast.
- d. Construct firing ports and barricades in and around positions.
- e. Rehearse contingencies for moving within and around positions.
- f. Construct cover using, preferably, reinforced concrete or brick. Improve cover with sandbags or ammunition cans filled with dirt or debris.
- g. Select observation positions that, at a minimum, permit observation of the adjacent unit's sector.
- h. Conceal firing positions back and away from windows and doors. Wet down areas around weapons to prevent dust signatures when firing.
- i. Select fields of fire and positions that are mutually supporting. Machine guns should have wire screens (cyclone fencing) to deflect grenades and to detonate rockets.
- j. Shut off gas and electricity to prevent fires. Prepare for the possibility of fires, floods, and electrical hazards.
- k. Stockpile food, water, ammunition, etc., if defending for an extended period.
- l. Select communications methods (e.g., primary wire, messenger, voice, hand and arm, air panels, phone) that support survivability.
- m. Plan escape routes and rehearse if time permits.
- n. Develop counterattack plan and identify force.
- o. Develop a retrograde plan.

---

# Countermechanized Operations

---

## 1. Tactical Considerations.

- a. Identify and prioritize mechanized avenues of approach and mobility corridors.
- b. Establish the means to detect enemy armor.
- c. Conduct intelligence preparation of the battlespace (IPB).
- d. Establish forces for security.
- e. Use the terrain to gain advantage.
- f. Ensure the barrier plan supports the defensive plan. Barriers are essential in the defense.
- g. Integrate all supporting arms into the combined-arms countermechanized scheme.
- h. Employ weapons in mass and in depth.
- i. Decide whether to fight from battle position(s) or sector(s).

## 2. Countermechanized Fires (two types).

- a. Concentric and ever-increasing volumes of fire delivered by—
  - 1 Heavy antitank weapon (HAW).
  - 1 Medium antitank weapon (MAW).
  - 1 Light antitank weapon (LAW).

- b. Massed surprise fires.
  - (1) Direct fire weapons engage simultaneously in an ambush.
  - (2) Supporting arms may be used in the same manner as concentric method.

### **3. Engagement Areas.**

- a. Use engagement areas as a tool to help concentrate fires and optimize fire distribution.
- b. Identify the engagement area by target reference points (TRPs) or by prominent terrain features.
- c. Design defense around avenues of approach, not around engagement areas.

### **4. Weapons Employment Considerations.**

- a. Mutual support.
- b. Overlapping sectors of fire.
- c. Dispersion.
- d. Primary, alternate, and supplementary positions.

### **5. Tactical Control Measures/Coordinating Instructions.**

- a. TRPs.
- b. Sectors of fire.
- c. Engagement criteria.
- d. Target precedence.
- e. Criteria for initiating fires (event, command, or time).

- f. Trigger lines/points.
- g. Break lines allow weapons to displace to alternate, supplementary, or successive positions.
- h. Successive battle positions.

---

# Engagement Areas

---

## 1. General Considerations.

- a. Used as a tool to concentrate fires and optimize their effects.
- b. Used most effectively with combined arms.
  - (1) Fixed-wing close air support (CAS).
  - (2) Rotary-wing CAS.
  - (3) Artillery.
  - (4) Tanks.
  - (5) Antitank guided missiles.
  - (6) Weapons organic to the infantry battalion/rifle company.
- c. Identified by target reference points (TRPs) on the corners of the engagement area or by easily recognizable terrain features around the engagement area.

## 2. Planning Considerations.

Determine the location of the engagement area based on mission, enemy, terrain and weather, troops and support available-time available (METT-T).

- a. Mission. Design the engagement area to produce the desired effects that support the scheme of maneuver. Different missions may favor different approaches.

- b. Enemy. Analyze the threat and task-organize and decide which portion (i.e., advance guard, main body, rear guard) to engage by determining the—
  - ┆ Size and configuration of enemy forces.
  - ┆ Distribution between echelons and composition of each.
  - ┆ Time available to prepare the engagement area.
- c. Terrain and weather.
  - (1) Identify restricted avenues of approach that limit the enemy's ability to deploy.
  - (2) Find the avenue of approach that allows the best—
    - ┆ Cover and concealment.
    - ┆ Avenues of egress for disengagement and employment of weapons at maximum range.
  - (3) Decide if terrain and weather favor massed surprise or concentric fires (HAW, MAW, LAW).
  - (4) Determine whether to defend by sector or from battle positions.
- d. Troops and support available. Attempt to overwhelm the enemy with different threats to put him in a dilemma or survival situation.
- e. Time available. Specify the time to move to the engagement area and get all units and obstacles set in place by determining—
  - ┆ How fast the enemy can move across the terrain.
  - ┆ How many shots can be taken into the engagement area.

- | How fast can a disengagement and egress back to the next position be accomplished.
- | How much ammunition is required for engagement and pre-stage ammunition at subsequent positions to expedite resupply.

### **3. Refinement Considerations.**

- a. When augmenting existing or natural obstacles, the obstacles may be used to—
  - (1) Stop the enemy.
  - (2) Split the enemy column.
  - (3) Divert the enemy column and reduce the width of the engagement area.
- b. When positioning direct fire weapons—
  - | Consider the enemy will target ideal positions from his map study.
  - | Select positions that aren't obvious yet meet the employment criteria.
  - | Use "hot/cold" fighting positions.
  - | Evaluate each weapon type individually.
  - | Use tanks to displace rapidly, to kill quickly and accurately, and to protect other elements as they egress.
- c. When calculating hit probability—
  - | Use the size of the engagement area.
  - | Consider the speed the enemy can move over the terrain.



- ┆ Determine the rate of fire and effects of other arms.
- ┆ Determine if the enemy can be stopped or merely slowed down.
- d. When employing rotary-wing CAS—
  - ┆ Use artillery suppression to limit exposure to enemy fires.
  - ┆ Select a holding area and two or more firing positions.
- e. When employing fixed-wing CAS—
  - ┆ Use well beyond the engagement area.
  - ┆ Use on trapped vehicles in and beyond the engagement area.
  - ┆ Use for counterbattery fire.
- f. When planning artillery, plan for fires beyond the engagement area, in the engagement area, and in front of the position.
- g. When establishing conduct of fire (sequencing) for each weapon—
  - ┆ Assign fire distribution by sectors of fire, TRPs, and trigger and break lines.
  - ┆ Specify fire control (on order or event oriented).
  - ┆ Determine engagement/disengagement criteria.
  - ┆ Establish target precedence.
- h. When establishing command and control for fires into an engagement area—
  - ┆ Centralized command is critical. The commander must control initiation of artillery, change target priorities as

required, change engage/disengage criteria as required, and conduct a rehearsal with all elements participating. This will ensure communication networks function, artillery is on target, and timing is on.

- l Decentralized control allows leaders to take rapid advantage of enemy weaknesses and exploit them. The commander must ensure all unit leaders are well briefed and have a clear understanding of the task, intent, and plan of engagement.
- i. When conducting contingency planning, develop plans that address no friendly artillery, no friendly CAS, significant enemy air threat, enemy suppression of artillery, early discovery of friendly positions, early enemy deployment, etc.



---

# Conducting Reconnaissance to Define and Build an Engagement Area

---

## 1. Identification.

Identify mobility corridors, avenues of approach, and key or decisive terrain.

## 2. Engagement Area (EA).

Determine the location of engagement area issued by higher headquarters.

## 3. Battle Position.

Determine the ground location of proposed battle position(s) and observation posts (OPs)/listening posts (LPs):

- ┆ Walk/drive the engagement area and area of operations if possible.
- ┆ Get the feel of the terrain in order to use it to gain advantage.
- ┆ Confirm or deny the information presented during the intelligence preparation of the battlespace (IPB) process.

## 4. Target Reference Points.

Identify target reference points (TRPs).

- a. Decide where to kill the enemy.

- (1) Mark and identify TRPs for massing fires on specific mobility corridors.
  - (2) Mark and identify TRPs for platoon sectors of fire.
  - (3) Look for possible obstacles positioning sites (based on mission, enemy, terrain and weather, troops and support available-time available [METT-T] analysis) while moving through the engagement area.
  - (4) Determine how these obstacles can be integrated into a coherent defense.
- b. Move vehicles and weapons into position. Drive the engagement area while gunners make range/sketch cards. Identify dead space.
  - c. Identify the proposed battle position from the enemy's perspective. Determine at what point concealment/surprise is lost.

## **5. Direct Fires.**

- a. Ensure support and fields of fire.
- b. Consider time of flight (antitank guided missiles [ATGMs]).
- c. Consider effective range.
- d. Consider cover, concealment, and camouflage.
- e. Consider flanking shots.
- f. Determine ability to maneuver.
- g. Determine displacement routes.
- h. Consider successive positions.

## **6. Indirect Fires.**

Plan indirect fires to cover dead space.

- a. Coordinate with adjacent units and confirm or deny their ability to provide overlapping fires.
- b. Mark and identify trigger lines with TRPs.
- c. Add trigger lines to range/sketch cards.

## **7. Vehicle Fighting Positions.**

Prepare vehicle fighting positions.

## **8. Obstacle Locations.**

Identify proposed obstacle locations and purpose (i.e., turn, fix, disrupt, block).

- a. Identify general obstacle location with engineer if available.
- b. Direct the engineer to mark specific obstacle locations on the ground.
- c. Verify that designated gunners can see obstacle markers, observe weapons effects, and cover obstacles with direct fire.
- d. Move obstacles to ensure observation of obstacles and effects. (Ensure that the new obstacle locations conform to the commander's intent.)
- e. Add proposed obstacles to range/sketch cards (i.e., change broken lines in graphics to solid as the obstacles are completed).

## **9. Dismounted Infantry Positions.**

Plan for dismounted infantry positions.

- a. Identify dismounted avenues of approach.
- b. Identify and mark dismounted infantry TRPs to guard obstacles; to cover dead space, flanks, and rear; and to hold key or decisive terrain.
- c. Identify dismounted infantry battle positions from the enemy's perspective.
- d. Designate and mark crew-served weapons and squad positions.
- e. Record sector limit data on fire plan sketch.
- f. Move Marines into position.
- g. Walk engagement area.
  - (1) Position mortars, M203s, and claymores to cover dead space.
  - (2) Mark and identify trigger lines with TRPs.
  - (3) Add trigger lines to range cards.

---

# Retrograde Operations: Delay

---

## 1. General Considerations.

- a. The force under pressure trades space for time and avoids becoming decisively engaged.
- b. The delaying unit simultaneously does the following:
  - ┆ Destroys as much of the enemy force as possible.
  - ┆ Causes the enemy to deploy repeatedly.
  - ┆ Preserves the friendly force's freedom of maneuver.
  - ┆ Conserves combat power to fight again.
- c. The higher headquarters defines the delay operation in terms of preservation of the force, as well as time and terrain.

## 2. Fundamentals.

- a. Ensure centralized control, but decentralized execution.
- b. Make maximum use of terrain to slow the enemy and gain advantage.
  - (1) Key terrain.
  - (2) Observation and fields of fire.
  - (3) Cover and concealment, including observation from the air.
  - (4) Obstacles, both natural and artificial.
  - (5) Avenues of approach, to include visibility, movement, fire support, and battlefield mobility.



- c. Force the enemy to deploy/maneuver.
  - (1) Slow the enemy's progress.
  - (2) Trade space for time.
- d. Avoid decisive engagement.
  - (1) Make the enemy deploy; develop the situation.
  - (2) Displace to the next position (successive delay/alternate delay) before the decisive engagement occurs.
  - (3) Assign platoon sectors for each avenue of approach within the company sector.

### **3. Control Measures.**

- a. Sectors for each committed unit are established by boundaries.
- b. Location of battle positions or defensive positions.
- c. Phase lines.
- d. Checkpoints.
- e. Location of observation posts/listening posts for each battle position or defensive position.
- f. Passage points.
- g. Routes (primary and alternate) from one position to the next.
- h. Location of supply routes or ammunition caches.
- i. Indirect fire targets, priority of fires, priority targets, and family of scatterable mines targets.
- j. Establishment and dissemination of criteria for disengagement.
- k. Destruction of friendly items and gear.

#### **4. Mobility Considerations.**

- a. The larger the mobility differential achieved by the delay force over the enemy, the greater the probability of success.
- b. Mobility is increased by—
  - 1 Conducting personal reconnaissance of all delay routes and delay positions.
  - 1 Improving existing roads and trails.
  - 1 Executing well-rehearsed movements.
  - 1 Ensuring proper siting of antiair and antitank guided missile assets.
  - 1 Positioning security forces at chokepoints.
  - 1 Evacuating casualties early.
  - 1 Caching excess supplies along delay routes.
  - 1 Controlling key terrain that dominates high-speed avenues of approach.
  - 1 Destroying selected roads and bridges.
  - 1 Improving natural obstacles and covering them by fire.
  - 1 Employing indirect fire and smoke to degrade the enemy's vision and rate of advance.

#### **5. Deception Considerations.**

- a. Take maximum advantage of darkness and periods of limited visibility.
- b. Employ dummy minefields and decoy positions.
- c. Maintain the normal radio traffic patterns.

- d. Employ proper radio procedures in disengaging units.
- e. Use demonstrations and feints to divert the enemy's attention from actual activities.

---

## **Retrograde Operations: Withdrawal**

---

### **1. General Considerations.**

- a. A planned operation in which a force in contact disengages from an enemy.
- b. Intention is to put distance between the friendly unit and the enemy as quickly and inconspicuously as possible.
- c. A withdrawal operation differs from a delaying operation in that the main purpose is to remove the force from the presence of the enemy.
- d. Elements may conduct delaying operations to gain time for the force to disengage.

### **2. Types of Withdrawal.**

- a. Withdrawal not under enemy pressure. Freedom of action is preserved.
- b. Withdrawal under enemy pressure, fighting to the rear.

### **3. Purpose.**

- a. To avoid destruction of the force.
- b. To avoid battle under unfavorable conditions.
- c. To draw the enemy into an engagement area.
- d. To allow the force to be used elsewhere.

### **4. Planning Considerations.**

- a. New locations of rear positions/assembly areas.
- b. Sectors/routes of withdrawal, guides, and traffic.

- c. Timing and sequencing of withdrawal.
- d. Composition and mission of detachments left in contact (DLICs) (e.g., 1/3 rifle company, 1/2 weapons platoon).
- e. Actions on enemy contact.
- f. Location/composition of ambushes.
- g. Supporting fire plan/displacements.
- h. Deception measures and tactical cover.
- i. Control measures (i.e., checkpoints, phase lines, initial points, and release points).
- j. Medical evacuation and movement of logistic trains.
- k. Traffic control measures/priorities.
- l. Alternate plans and counterattack plans.
- m. Commander's daylight reconnaissance.
- n. Destruction of equipment left behind.
- o. No communications plan/procedures.

## **5. Time of Withdrawal for the Detachment Left in Contact (DLIC).**

- a. On order.
- b. Designated time.
- c. Event.

## **6. Withdrawal Under Pressure.**

The covering force is behind the initial position, and there is no detachment left in contact.

## **7. Reasons for Delay.**

- a. Allow time to regain sufficient strength.
- b. Draw the enemy into an unfavorable position.
- c. Learn the enemy's intent through time and intelligence.
- d. Protect the main force.
- e. Gain time to reestablish defenses.

## **8. Fundamentals.**

- a. Characterize by centralized control and decentralized execution.
- b. Make maximum use of terrain and obstacles.
- c. Force the enemy to deploy and maneuver.
- d. Maintain contact.
- e. Avoid being decisively engaged.
- f. Develop a counterattack plan.
- g. Maintain a strong reserve.
- h. Require a reserve that only the commander can commit.
- i. Develop alternate plans.

## **9. Overlay.**

- a. Initial positions.
- b. Subsequent battle positions.
- c. Main battle force routes.
- d. Counterattack plans.
- e. Control measures for rear passage of lines.



---

## **Retrograde Operations: Retirement**

---

A retirement operation occurs when a force moves away from the enemy. Proper security is maintained during the movement since enemy conflict is probable.



---

# Rear Area Security

---

## 1. Principles.

- a. Rear area security is a Marine air-ground task force (MAGTF) commander's responsibility.
- b. Units are responsible for their own security.
- c. The rear area security effort will normally place minimal reliance on the ground combat element (depending on the enemy threat and situation).
- d. The rear area security effort must be balanced against the threat.

## 2. Security.

- a. The threat should be determined before deciding on a security plan.
- b. External and perimeter rear area security considerations are as follows:
  1. Are there established boundaries? (May organize into smaller, mutually supporting positions or a larger defensive position.)
  1. Where will avenues of approach be located?
  1. Can the site (e.g., obstacle, barrier/existing structure) be isolated?
  1. Are fortifications required?
  1. Where will access points and search points be located?
  1. Is a lighting plan necessary?

- ┆ Are berms or antivehicle ditches required?
  - ┆ Where will sentry posts (e.g., observation, fields of fire, mutual support) be located?
  - ┆ Are roving patrols necessary?
  - ┆ What are the specific weapons required for each post?
  - ┆ Have fires been coordinated with adjacent units? (Have impact areas been checked?)
- c. Internal rear area security considerations are as follows:
- ┆ Has the location response team of the reaction force been determined?
  - ┆ Are combat service support operations center, rear area operations center, and command post security procedures established?
  - ┆ Are observation posts feasible?
  - ┆ Are fortifications necessary?
  - ┆ Has a plan to control hired nationals been established?
  - ┆ Is a traffic plan established?

### **3. Planning Considerations.**

- a. Determine the number of Marines available.
- (1) Designate a chain of command.
  - (2) Ensure there are enough personnel for manning at least two reliefs, but three is ideal.
  - (3) Assign qualified Marines for each relief or crew-served weapons.

- (4) Designate a squad leader for each relief.
  - (5) Establish a command element (i.e., commander, senior enlisted, and radio/telephone operator).
- b. Determine the number of posts required.
- (1) Ensure mutual support.
  - (2) Determine access routes for the reaction force.
  - (3) Designate alternate and supplementary posts.
- c. Specify the types of posts.
- (1) Sentry post.
  - (2) Observation post.
  - (3) Duty watch in the rear area operations center.
  - (4) Vehicle search points.
  - (5) Pedestrian search points.
  - (6) Vehicle access points.
  - (7) Pedestrian access points.
  - (8) Combat service support operations center, rear area operations center, and command post security guards.
  - (9) Roving patrols.
- d. Specify personnel rotation and shift length (6 hours or less).
- e. Establish a crowd/mob control plan.
- f. Designate an internal reaction force (i.e., an off-duty relief of the security force).

- g. Establish rules of engagement (ROE) and determine constraints and restraints.
- h. Determine sentries' tasks.

#### **4. Observation Posts.**

- a. Planning considerations.
  - (1) Select overt or clandestine posts.
  - (2) Analyze mission, enemy, terrain and weather, troops and support available-time available (METT-T), including civil situation/routine.
  - (3) Conduct reconnaissance (pick site with an observation area, concealment area, and a covered entry/exit).
  - (4) Determine the observation post (OP) team (2- or 4-man) and equipment (e.g., binoculars, cameras, weapons).
  - (5) Plan time and method for occupation, relief, and watch routine.
  - (6) Plan for OP protection. Coordinate with reaction force/patrols.
  - (7) Determine action in case clandestine OP is compromised.
  - (8) Plan logistic (e.g., beans, bullets, Band Aids, bad guys [the 4Bs]; batteries; record log; cooking authorization).
  - (9) Plan for communications.

- b. Orders for observation posts (i.e., tasks, ROEs, and reports to higher headquarters).

## **5. Fortifications and Obstacles.**

- a. Fortifications are constructed considering enemy capabilities and limitation.
  - (1) Use sandbags. If possible, use engineers to determine the limitations of using sandbags on/in the building.
  - (2) Cover window screens to deny enemy observation and sniping. Also, tape windows to reduce blast effects.
  - (3) Protect the roof. Placing chain link fencing and welded mesh 1 meter above the roof will detonate incoming mortar projectiles. Use sandbags to absorb shrapnel.
  - (4) Use screens made of chain link fencing to protect against rocket propelled grenades and thrown rocks.
- b. Obstacles are used to slow down, turn, or stop enemy vehicles and personnel.
  - (1) Consider the enemy may use subsurface or sewer approaches.
  - (2) Stagger obstacles across the route to create a serpentine maze.
  - (3) Scatter single sandbags to create road bumps and create delays.
  - (4) Designate an access point.
  - (5) Illuminate fences, gates, and obstacles, if possible.
  - (6) Cover obstacles by observation and fire.

## **6. Reaction Force.**

- a. Consider assets available.
- b. Provide adequate mobility and firepower to counter threat.
- c. Establish procedures for employment and contingency plans.
- d. Rehearse.

# MILITARY OPERATIONS OTHER THAN WAR

---

## Counterinsurgency Operations

---

### 1. General Considerations.

Counterinsurgency operations are military, paramilitary, political, economic, psychological, and civic actions taken by a government to defeat insurgency. It is one of the most frustrating and difficult operations for a military force to execute. Its overall strategy will be crafted at the higher levels of command. Unit commanders will want to emphasize the following principles to their Marines.

- a. Political. Support of the people is the key to a lasting victory. Marines must understand the culture and customs of the local population. Commanders must give background classes on the nation's political history and conditions that led to the insurgency. If available, use native interpreters or scouts to teach basic language skills.
- b. Intelligence. Intelligence collection is fundamental to defeating the insurgent. While on patrol or moving, Marines should be on the lookout for anything unusual and immediately report information to higher headquarters.
- c. Tactical situation. Guerrillas strike at the time and place of their choosing. They may be inactive for long periods, strike after collecting detailed intelligence, and then flee, disperse,

- or blend into the population. Identification of the leadership/infrastructure is key to defeating the insurgent.
- d. Flexibility. Marines must be prepared to conduct a variety of tactical operations.
  - e. Mobility. Generally, guerrillas know the area, blend in with the population, and move relatively freely until they strike. Marines must deny this freedom of movement to the insurgent.
  - f. Minimum use of force. Marines must understand and observe the rules of engagement. Misuse of force can have repercussions among the local population and possibly within the U.S.'s allied political structure.
  - g. Patience. Marines must stay alert. Counterinsurgency operations are long and often boring. Guerrillas wait for the occupying force to become complacent and then strike. Emphasize security, security, security.
  - h. Reserves and reaction forces. Counterinsurgency operations usually saturate the area with small units and then reinforce rapidly when contact with the insurgent is made. The ability to communicate is essential; otherwise, small units risk being isolated/cutoff.

## **2. Tactical Tasks.**

- a. Security operations.
  - (1) Protect the populace.
  - (2) Conduct with or conducted by host nation military or police forces.



- b. Searches.
  - (1) Deny the guerrilla force freedom of movement.
  - (2) See appendix G for more information on these tactical tasks.
- c. Civil disturbance/riot control. See Crowd and Mob Control on page 103.
- d. Raids or strikes. Create doubt and uncertainty in guerrilla forces.
- e. Patrols.
  - (1) See Patrolling on page 131 and Urban Patrolling on page 143.
  - (2) Use saturation patrolling which is critical to any counterinsurgency operation.
- f. Ambushes. Deny the guerrilla force freedom of movement.
- g. Humanitarian operations. Perform medical/dental civic actions, rebuild schools/hospitals, distribute food, etc.
- h. Roadblocks. See appendix G for more information on these tactical tasks.
- i. Observation points—
  - ┆ Deliver information on the enemy.
  - ┆ Provide security for the force.
- j. Perimeter security. See Rear Area Security on page 83 for more information on these tactical tasks.
- k. The reaction force—
  - ┆ Provides a force that reacts to enemy actions.
  - ┆ Consists usually of light/heavy forces with an alert-to-execute timeline and rehearsed contingency plans.

---

## **Noncombatant Evacuation Operations**

---

The protection and safeguarding of qualified evacuees is the non-combatant evacuation operation (NEO) focus; however, protecting U.S. personnel is priority. Leaders use mission, enemy, terrain and weather, troops and support available-time available (METT-T) to adapt NEO mission planning and execution guidelines as appropriate.

### **1. Planning Considerations.**

- a. Has the location and number of evacuees been determined?
- b. What is the threat to evacuees and the NEO force (e.g., terrorist, insurgents, military)?
- c. Will the host government assist or resist the NEO efforts?
- d. Is the environment permissive, uncertain, or hostile?
- e. Where is the assembly area located per the emergency action plan?
- f. What is the categorical breakdown of evacuees (to include number and the black, white, gray list if appropriate)?
- g. Who is the senior U.S. official? Who are the senior officials?
- h. Have the location and number of third country nationals been determined?
- i. Have all sensitive U.S. properties and facilities that require security and/or destruction been identified?
- j. Where are the helicopter landing zones located? Have sizes, slopes, obstacles, etc., been identified?
- k. What type of medical support is required?

- l. What are the rules of engagement (ROE)?
- m. What is the evacuation plan?

## **2. NEO Mission Commander's Considerations.**

- a. Plan for possible deterioration to an uncertain environment.
- b. Plan on Marines and evacuees being exposed to equal degrees of danger.
- c. Prioritize evacuees.
- d. Evacuate personnel if in doubt as to their status.
- e. Plan for two or three times more than the number of evacuees briefed.
- f. Ensure that families are not separated.
- g. Ensure the evacuation control center (ECC) force has an organic reaction capability to deal with contingencies.
- h. Take health and comfort packs for evacuees.
- i. Use standing operating procedures when—
  - l. Preparing explosive ordnance pits.
  - m. Searching females.
  - n. Dealing with problem evacuees.
  - o. Handling pets.
  - p. Receipting valuables.
  - q. Exercising courtesy.
- j. Plan/build demolitions pits as necessary for handling unexploded and confiscated ordnance.
- k. Include a public affairs officer and staff judge advocate in the plan to provide media support and to answer claims.

- l. Plan for day/night operations.
- m. Request permission for use of riot control agents, if required.
- n. Show minimal force, but be prepared.
- o. Do not piecemeal units into the area.
- p. Take medical/chaplain support.
- q. Consider all Marine air-ground task force units for support/show of force.
- r. Develop, early in the planning process, a simple cross-deck plan to support planning requirements.
- s. Identify showstoppers early (NO GO criteria).
- t. Be prepared to leave stay behind forces, if required.
- u. Develop plans for the use of alternate sites and evacuation means as required.
- v. Develop plans for dealing with mass casualties during operations.
- w. Develop contingency plans for recovery of isolated evacuees.

### 3. Evacuation.

- a. Categories.

<b>Category</b>	<b>Tag</b>
I American citizens	red
II Alien members of American families	yellow
III Alien employees of U.S. Government/businesses	green
IV Third Country Nations and other designated aliens	blue

- b. Subcategories (listed from the highest to the lowest priority).
  - (1) Women obviously pregnant.
  - (2) Women with children, unaccompanied children under 18, and designated sponsors of unaccompanied children.
  - (3) Aged and infirmed individuals.
  - (4) Unaccompanied women 18 years or older.
  - (5) Men 18 or older.

#### **4. Small-Unit Screening, Processing, and Movement Considerations.**

- a. Instructions to Marines.
  - (1) ROE.
  - (2) Procedures for handling very important people (VIP).
  - (3) Procedures for handling women and dependents.
  - (4) Procedures for request for political asylum and temporary refuge.
  - (5) Procedures for handling combatants and infiltrators.
- b. Evacuee considerations.
  - (1) Designated VIPs are—
    - ┆ Handled with courtesy and respect.
    - ┆ Given priority of movement.
    - ┆ Assigned guides.
    - ┆ Provided health care and comfort.

- (2) Noncombatants are—
  - | Searched for contraband.
  - | Treated as third country nationals.
  - | Separated into groups of women, children, and disabled/injured people. Women are categorized into groups of mothers, unaccompanied women, and pregnant women.
- (3) Individuals seeking political asylum and refuge are—
  - | Given protection pending approval of their request by Department of State.
  - | Reported to higher headquarters.
  - | Denied refuge when their request for asylum is terminated.
  - | Not encouraged.
- (4) Combatants/infiltrators are treated as enemy prisoners of war (see app. H) and are—
  - | Searched for weapons and contraband.
  - | Segregated into groups.
  - | Silenced (enforce silence at all times).
  - | Evacuated quickly and humanely.
  - | Safeguarded (keep under guard and protect).
  - | Tagged as required to identify an individual's personal effects and equipment.

c. General evacuee treatment rules.

- (1) Consider evacuees are not prisoners of war, don't treat them as such.
  - (2) Use the minimum force required for the situation.
  - (3) Ensure that pets are left behind.
  - (4) Ensure that gifts, tips, or bribes are not accepted.
  - (5) Enforce baggage limitations.
  - (6) Keep people and their baggage together if possible.
- d. Site reconnaissance and liaison.
- (1) Department of State representative should accompany.
  - (2) Prospective staging/processing sites are identified.
  - (3) Security requirements are identified (e.g., protection from small arms and in direct fire).
- e. Establishment of presence at the evacuation site.
- (1) Identify yourself and your purpose.
  - (2) Reassure evacuees of their safety.
  - (3) Explain the procedures and safety considerations.
  - (4) Seek evacuees' cooperation.
- f. Processing procedures at the evacuation site.
- (1) Maintain order.
  - (2) Provide security.
  - (3) Provide guidance.
  - (4) Ensure timeliness.
  - (5) Ensure continuous flow of evacuees.

## 5. Example Organization of a Platoon-Sized Evacuation Control Center.

- a. Platoon sergeant is assigned responsibility for conducting reception/registration.
- b. One squad is assigned responsibility for conducting screening (i.e., verifies identification, conducts searches, and tags individuals and belongings).
- c. Corpsmen provide medical support.
- d. Appropriate individual(s) are designated to provide logistic support.
- e. One squad is assigned responsibility for embarkation of evacuees.
- f. One squad is assigned responsibility as security and reaction force.
- g. The diagram below depicts a typical ECC organization and flow pattern of evacuees.

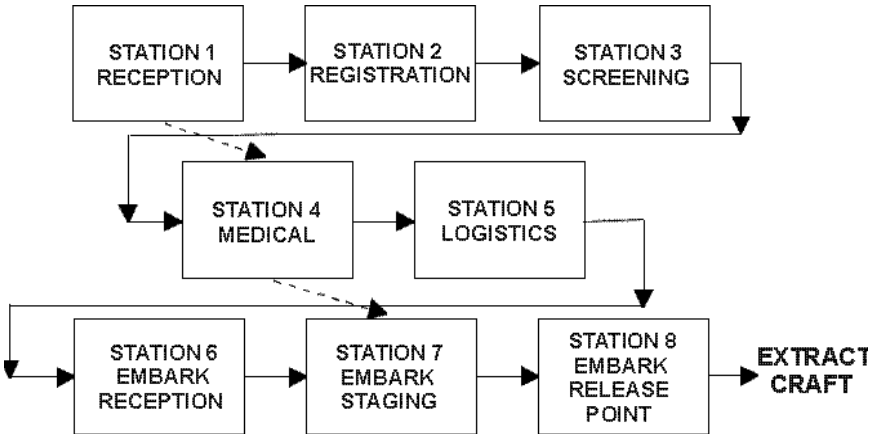



## **6. Inspections, Searches, and Movement Considerations.**

- a. Evacuees and their baggage are inspected for specified contraband, weapons, explosives, or sensitive items before boarding military aircraft or naval vessels. When conducting inspections—
  - 1. Brief evacuees on the practical reasons for conducting the search, especially safety concerns.
  - 1. Deny evacuation to any evacuee who refuses to submit to a search.
- b. Personal searches of female evacuees are conducted by female embassy or medical personnel.
- c. American ambassadors and other designated U.S. diplomats, their families, papers, or personal effects are not searched.
- d. Designated foreign diplomats, their families, papers, or property are immune from searches. Their personal baggage may be examined in their presence only if serious grounds exist to believe the baggage contains contraband.
- e. A foreign diplomatic pouch may not be searched, but the evacuation force command may deny the diplomatic courier transportation if the pouch is suspected of containing weapons or explosives.
- f. Embarkation procedures.
  - (1) Assemble and post functional details.
  - (2) Welcome/brief evacuees.
  - (3) Search personnel and baggage.
  - (4) Collect valuables and issue receipt.

- (5) Screen for medical problems.
- (6) Move to embark stations.
- g. Procedures at debarkation destination.
  - (1) Disseminate and brief debark plan.
  - (2) Debark in groups as designated in the debark plan.
  - (3) Make provisions for lodging and food.
  - (4) Customs (follow host government procedures; Department of State coordinates).
  - (5) Follow-on transportation is the responsibility of the Department of State.

---

# Crowd and Mob Control

---

## 1. Principles.

- a. Maintain flexibility to change tactics in an unstable situation.
- b. Rehearse procedures and drills.
- c. Give the appearance of minimum force with maximum troops.
- d. Establish control.
  - (1) Position leaders properly.
  - (2) Use a megaphone.
  - (3) Communicate with the crowd.
- e. Maintain all-round defense.
  - (1) Assign sectors of observation.
  - (2) Ensure 360-degree security.
- f. Use speed when deploying, arresting, and reacting to change.
- g. Gain surprise by being unpredictable.

## 2. General Approach.

- a. The best way to disperse rioters may be to make arrests and to make it plain that further rioting will result in physical discomfort to lawbreakers.
- b. Mob unity may be disrupted by threatening use of force, arresting leaders, and breaking the mob into smaller groups.

- c. Remember, whatever measures are taken, an escape route must always be left open to allow rioters to disperse.
- d. Escalating measures may require the application of force.

### **3. Escalating Orders.**

- a. Try to talk.
  - (1) Sit down with the riot leaders.
  - (2) Ensure Marines in riot gear are out of sight.
- b. Deploy if talking fails; move Marines quickly/efficiently into position.
- c. Give warning and instruct the crowd to disperse.
- d. Take pictures to use for prosecution of individuals and for psychological effect.
- e. Advance Marines equipped with riot gear in formation (skirmish line, wedge, or echelon).
  - (1) Choose formation based on desired destination.
  - (2) Drive against the obstacle that forces the mob to split with the intent to divide and disperse mob elements until mob cohesion is lost.
  - (3) Position units to follow in a column behind the advanced guard to support the advance and to pick up independent advanced guard duties as the crowd is forced down multiple side streets.
  - (4) Employ riot batons, riot control agents, water hoses, and fixed bayonets when appropriate.

- (5) Equip vehicles with people pushers (e.g., wood platforms or concertina rolls affixed to vehicles front).
- (6) Employ snipers only in a life-threatening situation.
- f. Dominate the area when the crowd begins to break up.
  - (1) Allow rioters to escape.
  - (2) Prevent rioters from massing in another location.
- g. Withdraw and return control to civil authorities.

#### **4. Summary.**

- a. Minimize the necessary force to maintain continuous control.
- b. Allow an escape route.
- c. Remember the principles.
- d. Escalate the use of force.
  - (1) Follow the rules of engagement.
  - (2) Practice constraints and restraints.
- e. Emphasize patience.
  - (1) Riots are very stressful.
  - (2) The mob mentality will eventually subside.

---

# Cordon and Search Operations

---

## 1. General Considerations.

- a. Understand the commander's intent.
- b. Exercise tight control over the unit during contact with civilians.
- c. Consider likelihood of contact, other than booby traps (contact inside the village may be minimal).
- d. Observe the behavior and reaction of children and parents at all times.
- e. Isolate those persons that need to be questioned.

## 2. Principles.

- a. Conduct a cordon and search operation with limited inconvenience to the population.
- b. Show respect for inhabitants, property, customs, etc.
- c. Conduct the search using local forces (e.g., militia, police) with U.S. assistance if possible.
- d. Execute as a combined civil and military operation.

## 3. Organization of the Force.

- a. Cordon element.
  - (1) Control access in and out.
  - (2) Use the largest element.

- b. Search element.
  - (1) Use as small an element as possible.
  - (2) If possible, search element should not contain U.S. personnel.
  - (3) Task-organize as needed into a minimum of:
    - ┆ Reconnaissance and search teams.
    - ┆ Population control team.
    - ┆ Prisoner control team.
    - ┆ Documentation team.
    - ┆ Medical team.
    - ┆ Census team.
- c. Reaction element.
  - (1) Use reserve.
  - (2) Position near the highest threat area.

#### **4. Intelligence Requirements.**

- a. The village.
  - (1) Physical layout (three-dimensional).
  - (2) Avenues of approach.
  - (3) Terrain and vegetation.
  - (4) Livestock/animals.
  - (5) Potential alarms.

- b. The inhabitants.
  - (1) Basic daily routine.
  - (2) Number of men in the village.
  - (3) Behavior of the children.
- c. Guerrilla activity (usually very little information is gained).
  - (1) Degree of training.
  - (2) Village (use and reliance).
  - (3) Security (type and degree).

## **5. Planning Considerations.**

- a. Task-organize cordon, search, and reserve force.
- b. Determine the method and time of establishing the cordon.
- c. Determine the approach/withdrawal route, time of entry, and main effort.
- d. Maximize observation to avoid gaps in the cordon.
- e. Consider the cordon to village distance may vary with the situation, but 800 meters is generally a good working distance.
- f. Locate the reaction element in the most critical area.
- g. Minimize the number of people entering town.
- h. Setting the cordon, emplacing the reaction element, and approaching the search element are the critical areas that will compromise the mission.



# SPECIFIC TACTICAL OPERATIONS

---

## Relief in Place: Relieving Unit

---

### 1. Planning Considerations.

- a. Conduct actual relief at night whenever possible to reduce vulnerability/threat. (Assume the enemy is observing.)
- b. Conduct daylight reconnaissance by company commander/platoon commanders and liaison personnel (guides).
  - (1) Designate area.
  - (2) Designate routes.
  - (3) Determine guide linkup points.
  - (4) Become familiar with—
    - | Defense (fire plan sketch/overlay).
    - | Terrain.
    - | Enemy situation.
    - | Fire support plan.
  - (5) Coordinate command post location (collocate if possible).
  - (6) Determine the reconnaissance method (i.e., unit or echelon, indepth or adjacent).

- (7) Leave liaison personnel with the unit to be relieved.
  - (8) Keep personnel informed of all changes.
  - (9) Walk/talk through the evolution. (Leaders must ask themselves: Can the mission be accomplished from this position?)
- c. Make arrangements for—
- 1 Turnover of fire plan sketches, range cards, minefield records, obstacle records, etc.
  - 1 Turnover of excess barrier material, wire, mines, stock-piled ammunition, etc.
  - 1 Exchange/turnover of machine gun tripods, mortar base-plates, field phones, camouflage netting, etc.
  - 1 Guides to mark the route to platoon and squad release point.
  - 1 Attachment of crew-served weapons for movement to the unit in whose area the weapons' position is planned.

## **2. Tactical Considerations.**

- a. Command post is located to best coordinate relief (collocate command post if possible).
- b. Company is moved to platoon release points.
- c. Platoons are guided to squad release point.
- d. At squad release points—
  - (1) Guides from an outgoing unit lead the squad to the defensive position.
  - (2) One fire team is relieved at a time.

- (3) Each man is briefed by the outgoing man and receives range cards, etc.
  - (4) Crew-served weapons are relieved after rifle units. Range cards are received.
  - (5) Local security is relieved last.
- e. A clear event/time for battle handover/passage of command is designated. Battle handover usually occurs when two-thirds of the unit is in place.

---

## Relief in Place: Unit to be Relieved

---

Leaders must address the following planning considerations:

- | Company/platoon commanders remain in place during relief units' reconnaissance.
- | Company commander/executive officer coordinate the tentative plan (e.g., routes/guides).
- | The executive officer and platoon representatives are tasked to—
  - Reconnoiter the route for the relieving unit.
  - Provide and man guide locations.
  - Coordinate and reconnoiter the new area to be occupied.
- | The commander of the unit to be relieved links up with the commander of the relieving unit. Commanders must determine—
  - Command post location (collocate if possible).
  - Turnover of excess ammunition and supplies.
  - Turnover of fire plan sketches, obstacle barrier plans, etc.
  - Exchange of crew-served weapons, etc.
- | Company/platoon commanders brief incoming unit commanders on—
  - Enemy situation.
  - Defensive layout.

- n Terrain.
- n Fire support plan.
- n Fire plan sketch/overlay.
- n Communications (especially if hard-wired).
- | Company/platoon commanders designate—
  - n Squad release points for the incoming unit.
  - n Guides for each squad.
  - n Sequence of relief.
  - n Rifle units (individual briefs).
  - n Automatic weapons locations.
  - n Local security.
- | Weapons crews are attached to rifle platoons for movement.
- | Squads move to platoon assembly areas once they are relieved.
- | Platoons move to the company assembly area once the platoon is relieved.

---

## Passage of Lines: Passing Unit

---

### 1. Planning Considerations.

- a. Bypass units whenever possible. (Passage of lines is difficult and time consuming.)
- b. Determine the enemy situation. (Is the unit moving forward toward the enemy or rearward away from the enemy?)
- c. Determine tactical employment of the unit being passed (include fire support overlays and communication plans).
- d. Determine security measures of the stationary unit.
- e. Conduct reconnaissance for—
  - 1 Areas, lanes of passage, release points, linkup points, and check points.
  - 1 Command post/combat operations center location.
- f. Specify the number of guides needed.
- g. Develop security measures for both units during passage.
- h. Plan fire support.
  - (1) Extent.
  - (2) Type.
  - (3) Control measures.
- i. Provide logistic support for the casualty collection point, enemy prisoners of war, etc..
- j. Establish conditions for when passage of command occurs.

## **2. Passage Considerations.**

- a. Link up with the stationary unit.
- b. Establish collocated command posts/combat operations centers.
- c. Direct to guides linkup.
- d. Deploy the security element to clear the area forward of the release point.
- e. Use smoke to screen passage.
- f. Conduct passage quickly.
- g. Decide on required conditions for the passage of command.
- h. Notify all subordinate units when passage of command is conducted.

---

## Passage of Lines: Stationary Unit

---

The commander of the stationary unit normally controls the conduct of the passage of lines. Leaders must address the following planning considerations:

- | Provide intelligence report (enemy situation) to the passing unit.
- | Provide tactical plans (include fire support overlay and communications plans).
- | Provide guide(s) for reconnaissance to be conducted by elements of the passing unit.
- | Brief the moving unit on security measures.
- | Provide recommendations on routes.
- | Coordinate linkup passage, command post location, and command relationship.
- | Provide guides at designated points.
- | Brief the extent, type, and control measures for provided fire support.
- | Determine the extent of logistic support for casualty collection points, enemy prisoners of war, etc.
- | Conduct the passage of command at a time mutually agreed upon by both units. If command is transferred prior to passage, the passing unit controls the unit positioned in contact with the enemy.
- | Inform all subordinated units of the passage of command.





---

# Linkup Operations

---

## 1. Concept of Operations.

The key to a rapid and successful operation is a clear understanding of the units' responsibilities and the recognition of signals used.

- a. Stationary force tasks.
  - (1) Recommend the establishment of a restricted fire line to the fire support coordinator.
  - (2) Recommend the time and location of primary and alternate linkup points to the S-3.
  - (3) Man linkup points.
  - (4) Reply to the linkup force's long-range and short-range recognition signals.
  - (5) Provide guides for the linkup force.
  - (6) Provide lanes/routes through obstacles to facilitate linkup force movement.
  - (7) Provide assembly areas for the linkup force.
  - (8) Provide information on recent enemy activity.
- b. Linkup force (moving force) tasks.
  - (1) Arrive on time at designated linkup point or switch to the alternate linkup point.
  - (2) Initiate long-range and short-range recognition signals.
  - (3) Prepare to continue the operation.

- c. Higher headquarters tasks.
  - (1) Establish command relationship and responsibilities of the joining forces.
  - (2) Coordinate fire support to include control measures (e.g., restrictive fire line).
  - (3) Designate primary and alternate linkup points.
  - (4) Estimate time of linkup.
  - (5) Designate one unit to assume stationary force tasks if both units are moving.

## **2. Coordinating Instructions.**

Commanders establish contact as early as possible to coordinate:

- | Linkup time and command relationships of units involved.
- | Mutual recognition signals (i.e., near, far, and alternates).
- | Communications plan.
- | Schemes of maneuver (to include control measures).
- | Action to be taken after linkup. Units maintain security by continuing the mission as quickly as possible.
- | Exchange of liaison officers.
- | Alternate plans to include routes, lanes, and linkup points.

## **3. Command and Signal.**

- a. Identify primary and alternate frequencies and call signs.
- b. Designate long- and short-range recognition signals for both day and night, as well as alternates for each.

---

## Infiltration

---

Leaders must address the following general planning considerations:

- | Release point locations and markings.
- | Time of release.
- | Point of departure.
- | Assembly areas are defensible, concealed, and large enough for an entire unit. (The first unit organizes the assembly area and provides guides.)
- | Time the infiltration must be completed.
- | Lanes or guides.
- | Single lane or multiple lanes (see page 124).
- | Rendezvous point, alternate rendezvous point, and time of rendezvous.
- | Lost-man procedures.
- | Escape and evasion procedures.
- | Contact procedures.
- | Near and far recognition signals.
- | Route to attack position.
- | Objective.
- | Fire support.

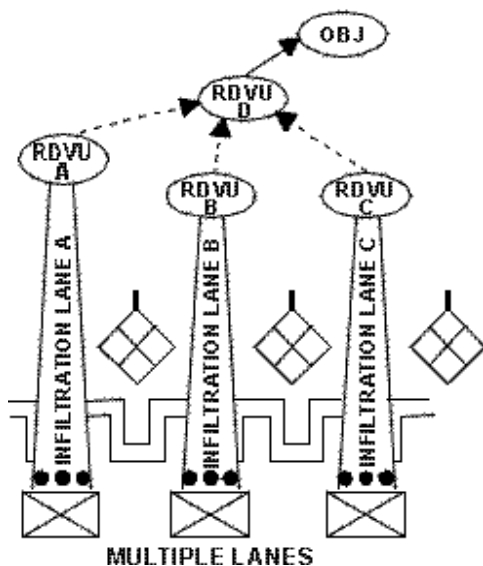
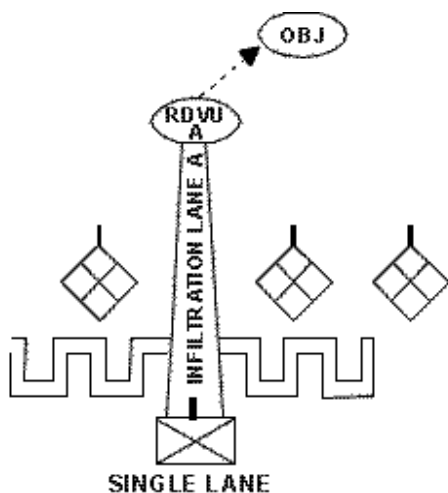

- | Size of moving units.
- | Planned fires in event of compromise.
- | Separation between units (time is generally better than distance).

---

# Convoy Operations

---

## 1. General Considerations.

- a. Determine type of convoy.
  - (1) Administrative.
  - (2) Tactical.
- b. Determine the formation.
  - (1) Open column:
    - | Normally used during the day.
    - | Vehicles are spaced between 50 to 100 meters apart.
    - | May be used at night with infrared radiation lights, blackout lights, chemlights, etc.
  - (2) Close column:
    - | Normally used at night.
    - | Vehicles are spaced approximately 25 meters apart or to the limit of observation of preceding vehicles' blackout lights.
  - (3) Infiltration:
    - | Normally used when security (vice speed) and dispersion are critical.
    - | Vehicles are dispatched individually, in small groups, or at irregular intervals along one or multiple routes.

- c. Determine the number and type of vehicles in the convoy structure (head, body, tail).
- d. Determine fire support requirements.
  - (1) Designate planned, on-call targets.
  - (2) Use priority targets.
  - (3) Consider aviation support (e.g., rotary-wing close air support for escort, route reconnaissance, and unmanned aerial vehicles).
- e. Determine common control measures.
  - (1) Start point/release point.
  - (2) Contact points.
  - (3) Critical points.
  - (4) Passage points.
  - (5) Passage lanes.
  - (6) Routes (primary and alternate).
  - (7) Checkpoints.
  - (8) Phase lines.

## **2. Planning Considerations.**

- a. Treat a convoy as a vehicular patrol.
- b. Brief actions on enemy contact from—
  - ┆ Front.
  - ┆ Rear.



- l. Left.
  - m. Right.
  - n. Sniper.
  - o. Ambush both road not blocked and road blocked scenarios.
- c. Plan and brief actions at security halts, both long and short.
  - d. Plan and brief actions for disabled vehicles.
  - e. Plan and brief actions at the destination.
    - (1) Security force tasks.
    - (2) Drivers tasks.
    - (3) Specific duties.
  - f. Plan for primary and alternate means of communication.
    - (1) Position radios with each element.
    - (2) Use pyrotechnics, flags, air panels, and hand and arm signals as alternate means of communications.
    - (3) Develop signal plan and action drills.
  - g. Plan for the use of guides.
    - (1) Establish their duties.
    - (2) Plan for their collection.
  - h. Plan and brief actions at critical points (i.e., chokepoints).
  - i. Establish march and catchup speed.
  - j. Prepare tactical vehicles.
  - k. Designate air sentinels and mark designated vehicles with air panels.

# PATROLLING

---

## Patrol Steps

---

### 1. Patrolling Principles.

- a. Detailed planning.
- b. Productive and realistic rehearsals.
- c. Thorough reconnaissance.
- d. Positive control.
- e. All-around security.

### 2. Types of Patrols.

- a. By mission.
  - (1) Reconnaissance.
  - (2) Combat.
- b. By mobility.
  - (1) Foot.
  - (2) Motorized.
  - (3) Waterborne.
  - (4) Helicopterborne.

### **3. Patrol Planning Steps.**

Consider all patrol steps when planning and use only those that are necessary. The order of the steps may vary.

- a. Study the mission.
- b. Plan use of time (backwards planning).
- c. Study terrain and situation.
- d. Determine requirements.
- e. Organize the patrol.
- f. Select men, weapons, and equipment.
- g. Issue a patrol warning order.
- h. Coordinate continuously. (See app. I.)
- i. Make reconnaissance.
- j. Complete detailed plans.
- k. Issue the patrol order.
- l. Supervise at all times, inspect, rehearse.
- m. Execute the mission.

### **4. Patrol Warning Order.**

The patrol warning order consists of the following (consider posting for all):

- a. A brief statement of the situation (enemy and friendly).
- b. Mission of the patrol.
- c. General instructions.
  - (1) General and special organization.
  - (2) Uniform and equipment common to all.

- (3) Weapons, ammunition, and equipment.
  - (4) Chain of command.
  - (5) A time schedule for the patrol's guidance (backwards planning).
  - (6) Time, place, uniform, and equipment for receiving the patrol leader's order.
  - (7) Times and places for inspections and rehearsals.
- d. Specific instructions.
- (1) To subordinate leaders.
  - (2) To special purpose teams or key individuals.

---

## Patrol Order Information

---

### 1. Task Organization.

- a. Units (maintain unit integrity as much as possible).
  - (1) Security. Address position in formation and responsibilities.
  - (2) Headquarters. Address position in formation and responsibilities.
  - (3) Assault. Address position in formation and responsibilities. Designate any subunits required (teams).
  - (4) Support. Use as required. Comprised mainly of units organic to patrol.
  - (5) Reconnaissance/reconnaissance and security as required. Include designation of required subunits (teams).
  
- b. Teams.
  - (1) Assault. Use A, B, C, etc., to designate if more than one assault team.
  - (2) Reconnaissance/reconnaissance and surveillance. Use A, B, C, etc., to designate if more than one reconnaissance team.
  - (3) Aid/litter. Provide specific instructions.
  - (4) Search/enemy prisoner of war. Provide specific instructions.
  - (5) Demolition. Prepare claymores or satchel charges for the mission.

- c. Key individuals.
  - (1) Team leader is in charge of the patrol and responsible for its conduct. The team leader provides detailed instructions to subordinates.
  - (2) Assistant patrol leader (APL) is second in command. The team leader provides the APL with detailed instructions on responsibilities, including details on any collateral duties.
  - (3) Navigator is responsible to the team leader for navigating the patrol.
  - (4) Radio operator is responsible to the team leader for communication.
  - (5) Pacers are responsible for conducting and passing pace counts.
  - (6) Flanks are responsible to the team leader for flank security during movement.
  - (7) Recorder records all essential information.
- d. Reserves.

## **2. Coordinating Instructions.**

- a. Specify time of departure.
- b. Specify time of return.
- c. Designate the primary route azimuths and distances for each leg and illustrate the route on the terrain model.
- d. Designate the alternate route azimuths and distances for each leg and illustrate the route on the terrain model.

- e. Organize for movement and prepare detailed layout of patrol formation that may be depicted on a diagram.
- f. Specify procedures for actions on enemy contact. Talk through the plan in detail to include transitional movements of units/teams.
  - (1) Hasty ambush (front, flanks, rear).
  - (2) Immediate assault (front, flanks, rear).
  - (3) Counter ambush (near/far).
  - (4) Break in contact (include plan for specifying direction and distance of movement).
  - (5) Reaction to indirect fires (direction and distance).
- g. Specify procedures for actions in the objective area. Omit for security patrols, but planning will be extensive for ambush, raid, or reconnaissance patrol. Address occupation of the final preparation position to objective rally point.
- h. Specify procedures for departure of friendly lines in detail (use terrain model to talk through).
- i. Specify procedures for reentry of friendly lines in detail (include primary and alternate communications plan as well as linkup plan).
- j. Specify procedures for actions at rally points. The plan should be talked through (include GO/NO GO plan and escape azimuth, as well as the location of any tentative rally points).
- k. Specify procedures for actions at danger areas, both linear and cross compartment, but emphasize the differences.

- l. Specify procedures for actions at halts. Delineate between long and short halts.
- m. Specify procedures for rehearsals and inspections. Prioritize actions to be rehearsed.
- n. Specify debrief.
  - (1) Location.
  - (2) Time.
  - (3) Attendees.



---

# Ambush Patrol

---

## 1. Principles.

- a. Surprise.
- b. Coordinated (violent) employment of fires to include supporting arms to isolate the area.
- c. Control is most critical when the enemy is approaching the kill zone.

## 2. Factors for Successful Ambush.

- a. Favorable terrain.
- b. Prior planning.
- c. Occupation procedures.
- d. Control measures.
- e. Security.
- f. Patience.
- g. Movement techniques and individual actions.
- h. Fire support planning.

## 3. Ambush Site Selection Considerations.

- a. Availability of natural obstacles can canalize the enemy and/or protect the withdrawal.
- b. A suitable ambush site is also good for the enemy.

- c. Maps and photographs are good, but sites should be seen firsthand.
- d. The selected site should allow the force to egress down a reverse slope.

#### **4. Organization.**

- a. Assault element.
- b. Security element.
  - (1) Secures objective rally point/final preparation position.
  - (2) Provides flank/rear security during occupation.
- c. Support element is optional. Fires complement the assault element.
- d. Patrol headquarters.

#### **5. Occupation of the Site.**

- a. Position security quickly/quietly.
- b. Establish communications.
- c. Position machine guns, squad automatic weapons, and grenadiers.
- d. Position all other weapons and assign sectors.
- e. Prepare claymores, flares, etc.
- f. Select location to initiate the ambush (patrol leaders).
- g. Estimate completion time for preparation.

## **6. Preparation of the Kill Zone (if necessary).**

- a. Once occupation of the ambush site is completed, commence preparation of the kill zone.
- b. Patrol leader alerts security/support elements that the assault element is moving into kill zone.
- c. Assault element leader moves the team into the kill zone.
  - (1) Demolition teams emplace mines/demolitions.
  - (2) Remaining assault element emplaces claymores/obstacles.
  - (3) Teams report to the assault element leader when preparations are complete and when positions are reoccupied.
  - (4) Assault element leader makes final inspection of the kill zone.
  - (5) Assault element leader reports to the patrol leader.

## **7. Execution.**

- a. Use designated signals to alert, initiate ambush, lift/cease fires, and withdraw.
- b. Enforce fire discipline when fire is initiated. Fires are—
  - ┆ Immediate.
  - ┆ Heavy.
  - ┆ Accurate.

- c. Ensure a security or assault element covers the far side if the kill zone must be searched.
- d. Withdraw quickly and quietly. Consider the use of booby traps during withdrawal.

## **8. Other Considerations.**

- a. Tailor equipment and weapons to the mission.
- b. Use field phones or signals (use radio communications by exception).
- c. Minimize time spent in the vicinity of the kill zone by conducting rehearsals and reaction drills and by following standing operating procedures.
- d. Wait patiently to allow the enemy main body to enter kill zone.
- e. Cover withdrawal with mines, booby traps, riot control agents, and supporting fires.

---

# Urban Patrolling

---

## 1. General.

The following basic patrolling principles and techniques apply to permissive and uncertain urban environments:

- | Overt presence (attempt to establish a positive U.S. presence and the support of the population).
- | Depth (urbanized terrain usually limits a patrol's ability to disperse laterally and to maintain dispersion along the length of the patrol formation).
- | Mutual support (positioning of units within the patrol in depth enables one unit to cover another's movement [traveling security]).
- | Deception/pattern avoidance (vary patrol routes, duration, and departure times).
- | Intrapatrol communications (each unit within an urban patrol should have the means to communicate).
- | Establishment of a reaction force.
- | Three-dimensional threat (pay constant attention to the three-dimensional urban environment).

## 2. Patrol.

- a. Methods.
  - (1) Dismounted.
  - (2) Vehicular.

- (3) Helicopterborne.
- b. Types.
  - (1) Security patrols make up the vast majority of urban patrols.
  - (2) Combat patrols are employed to—
    - Secure information.
    - Confuse the enemy.
    - Destroy installations.
    - Seize materials or suspicious individuals.

**3. Planning Considerations.**

- a. Rules of engagement must be understood by every Marine.
- b. Constraints and restraints may change frequently in response to changing situations.
- c. Unit integrity of the fire team/squad should be maintained.
- d. The vulnerable nature of patrolling requires subunits to provide for their own security in addition to the combat aspect of the mission.

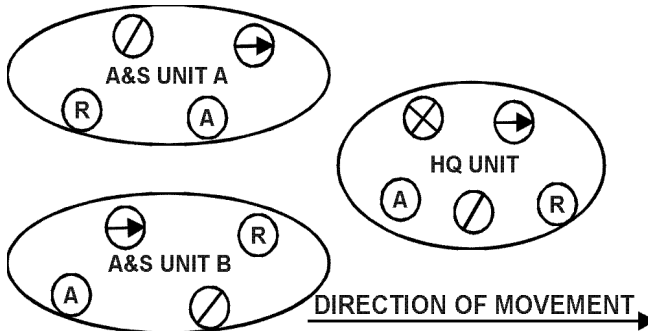

- e. Combined assault and security teams are employed to ensure all-around security.

#### **4. Task Organization.**

- a. Task-organize to meet the specific mission requirements.
- b. Use attachment specialists:
  - ┆ Explosive detection dogs and their handlers.
  - ┆ Marine interrogator translator team and counterintelligence team.
  - ┆ Explosive ordnance disposal personnel.
  - ┆ Communications personnel.
  - ┆ Members of host nation or allied military forces.
  - ┆ Interpreters.
  - ┆ Local community leaders.
  - ┆ Local law enforcement officers.
  - ┆ Public affairs Marines as media personnel escort(s).

---

## Urban Patrol Tips

---

### 1. Movement Considerations.

- a. Move within the patrol under observation/cover of other individuals.
- b. Know where cover can be taken in case of a hostile incident.
- c. Plan for contact with civilians, especially children.
- d. Expect the presence of moving and stationary vehicles along the route.
- e. Have a plan to deal with approaching dogs.
- f. Limit the use of camouflage to avoid frightening and confusing the local population (situational).
- g. Vary the movement rate during the day, which can range from short halts to brief double time.
- h. Take up mutually supporting firing positions that change frequently during short halts.
- i. Ensure at least one unit/team is in motion at all times during platoon-sized patrols.
- j. Work in pairs, ensuring mutual support.
- k. Stay within sight of assigned buddy; last man in unit/team provides rear security.

### 2. Patrol Formation Considerations.

- a. The need for immediate firepower outweighs the dangers of becoming canalized.



- b. The headquarters element is located near the front of the patrol.
- c. Assault and security elements follow in trace and maintain unit integrity on separate sides of the street.
- d. Platoon-sized squads generally travel abreast of each other, along parallel routes.
- e. The interval between units depends on mission, enemy, terrain and weather, troops and support available-time available (METT-T), but is usually 100 to 150 meters.

### **3. Control Measures.**

- a. Checkpoints and phase lines are located in association with major streets, alleys, buildings, etc.
- b. The detailed patrol overlay (see app. J) is forwarded to higher headquarters.
- c. The terrain model is maintained at higher headquarters to aid in supervision and control.

### **4. Individual Tasks.**

- a. Task marksman to engage point targets.
- b. Look out for suspicious or known insurgent vehicles.
- c. Attempt to recognize previously identified enemies.
- d. Attempt to gain information from casual conversation.
- e. Search vehicles and personnel.

## **5. Hostile Incident Indicators.**

- a. Observers on rooftops, in windows, etc., who are obviously tracking the patrol.
- b. The unusual absence of pedestrian traffic, people on porches, etc.
- c. Stores, markets, or street vendors closed suddenly or without explanation.
- d. A dramatic change in civilian attitude toward patrol members.
- e. Unfamiliar individuals, roadblocks, or vehicles within the patrol area.
- f. Vehicles riding unusually low due to overloading (i.e., ferrying people and weapons).
- g. Agitators trying to provoke an incident with patrol members.
- h. Civilian workers failing to appear at U.S. bases, etc.
- i. Normal deliveries, pickups, etc., which are late or early without reason.

## **6. Immediate Action Drills.**

- a. Bomb threat/discovery (cordon off and control area).
- b. Sniper (seek cover, identify position, limit collateral damage depending on rules of engagement, and attempt to cut off escape routes).
- c. Hostile individuals/crowd (see Crowd and Mob Control on page 103).
- d. Decisive engagement (treat as a conventional attack).

## PART II

# FIRE SUPPORT

*“There is still a tendency in each separate unit . . . to be a one-handed puncher . . . the rifleman wants to shoot, the tankier to charge, the artilleryman to fire . . . . That is not the way to win battles. If the band played a piece first with . . . the brass horn, then the clarinet, . . . there would be a . . . lot of noise but no music. To get harmony in music each instrument must support the others. To get harmony in battle, each weapon must support the other. Team play wins.”*

General George S. Patton  
(MCDP 1-3, *Tactics*, p. 41)



Property of the U.S. Marine Corps

Fire support section, defensive position.  
(Beirut, Lebanon 1982)

# GENERAL FIRE SUPPORT

---

## General Information

---

### 1. General Considerations.

- a. What is the mission?
- b. What is the enemy situation?
- c. What is the scheme or maneuver?
- d. What is the zone of action or defensive sector?
- e. What are the most likely avenues of approach?
- f. What are the priority targets?
- g. What are the desired effects (damage criteria)?
- h. Which subordinate unit is the main effort, and who has priority of fires?
- i. Will priority of fires or priority targets shift, if so, on what signal?
- j. Where are special fires (e.g., smoke, improved conventional munition)?
- k. Is there a requirement to register fire support assets?
- l. Are there restrictions on supported arms; if so, are restrictive fire support coordination measures needed?
- m. What maneuver control measures have been established?
- n. What additional fire support assets have been allocated?
- o. What are the future plans or on-order missions?

- p. Are there command and control (C<sup>2</sup>) or communications requirements that are different from the standing operating procedure requirements?
- q. What is the guidance on counterfire?
- r. What is the guidance on suppression of enemy air defenses?
- s. How much time is available?
- t. What is the ammunition status?
- u. What are special fuze or shell considerations?

## 2. Planning Considerations.

### a. Offense.

- (1) Plan fires to cover movement to the objective. Screen, obscure, and/or use deception to cover C<sup>2</sup> assets, fire support assets, observation posts (OPs), listening posts (LPs), and landing zones.
- (2) Plan fires to cover movement to the assault position. Request/plan priority target on suspected or likely strong points or ambush sites.
- (3) Plan fires to support the attack by—
  - ▮ Preparing the objective.
  - ▮ Preparing OPs/LPs.
  - ▮ Considering the use of smoke to support the deception effort.
  - ▮ Targeting likely assembly areas (AAs) for reinforcements.

- (4) Plan fires in support of exploitation by—
  - Pursuing fire along likely withdrawal routes.
  - Fixing on the enemy to destroy with direct fires.
- b. Defense.
  - (1) Plan fires forward to canalize/reduce the enemy force by—
    - Moving the enemy to the engagement areas.
    - Targeting AAs, C<sup>2</sup> assets, and fire support assets.
  - (2) Plan fires on the flanks to deny the enemy a likely assault position, probable line of deployment, and infiltration routes. Register targets in zone.
  - (3) Plan fires on the defensive position and final protective fires to support planned counterattack or to cover disengagement/withdrawal.
  - (4) Plan fires behind the position to cover the withdrawal of friendly forces. Prevent enemy envelopment from the rear.
  - (5) Confirm targeting decisions with the weapons platoon/company commander.
  - (6) Add, delete, or amend the fire support plan and then submit to higher headquarters.
  - (7) Report higher headquarters response to the commander.
  - (8) Write up fire support plan.

- (9) Refine, refine, refine (top-down, bottom-up planning).
- (10) Execute.

---

# Company Fire Support Planning

---

## 1. General Considerations.

- a. Like the regiment's and battalion's fire support planning, company fire support planning must mirror the planning process.
- b. At the company level, the planning process consists of troop leading steps commonly referred to as begin planning, arrange for reconnaissance, make reconnaissance, complete the plan, issue the order, and supervise (BAMCIS).
- c. The following planning considerations list the fire support actions during each step of BAMCIS.
- d. These actions may be accomplished simultaneously or in any sequence.
- e. The company fire support planner must organize to meet all these requirements in a time constrained environment.

## 2. Planning Considerations.

- a. Begin planning.
  - (1) Update friendly and enemy situations.
  - (2) Determine available assets, allocations, and fire support coordinating measures.
  - (3) Obtain the battalion's target list worksheet, fire support execution matrix (FSEM), and attack guidance.



- (4) Understand the battalion fire support plan and how it effects the company.
  - (5) Identify essential fire support tasks (EFSTs) for your company.
  - (6) Brief the command on the above.
  - (7) Receive the commander's restated mission.
  - (8) Receive the commander's guidance for fire support.
  - (9) Participate in the development of the company warning order.
  - (10) Issue the warning order to fire support personnel and mortar section on fire support specific issues.
- b. Arrange for reconnaissance.
- (1) Conduct map analysis.
  - (2) Plot obstacles and known enemy locations.
  - (3) Plot all battalion targets.
  - (4) List EFSTs.
  - (5) Advise the commander if guidance can or cannot be met with available assets and allocations.
  - (6) Refine battalion targets, if necessary.
  - (7) Determine if battalion targets support the commander's guidance.
  - (8) Plot targets necessary to support the commander's guidance (within the target allocation).

- (9) Determine the purpose, engagement criteria, trigger points, and primary and alternate executors.
  - (10) Develop the target list worksheet.
  - (11) Develop FSEM.
  - (12) Brief the commander on the initial fire support plan.
- c. Make reconnaissance.
- (1) Ensure battlefield observation is maintained.
  - (2) Accompany maneuver leaders on reconnaissance.
  - (3) Confirm or modify the plan.
  - (4) Verify target locations, trigger points, and primary and alternate observation plans.
- d. Complete the plan.
- (1) Modify the plan as necessary after reconnaissance.
  - (2) Brief the commander on the scheme of fires.
  - (3) Emphasize observer movement, observation post requirements, and triggers.
  - (4) Receive fire support plan approval.
  - (5) Transmit the target list worksheet and coordination requirements to the battalion fire support coordination center and the company mortars section.
  - (6) Brief fire support personnel on the fire support plan.

- e. Issue the order.
  - (1) Participate in the company order brief.
  - (2) Ensure fire support representatives and the mortar section leader attend the order brief if possible.
- f. Supervise.
  - (1) Conduct rehearsals.
  - (2) Conduct inspections (as required).
  - (3) Continue to refine targets and triggers for actual location, ground reconnaissance, or new enemy information.
  - (4) Continuously update and coordinate the plan as necessary.

---

# Suggested Fire Support Coordinator Standing Operating Procedure

---

## 1. Suppression.

- a. Immediate suppression/immediate smoke is provided by the indirect fire support agencies in the following order of precedence:
  1. Naval gunfire.
  1. Artillery.
  1. 81mm mortars.
  1. 60mm mortars.
- b. The most responsive asset is the company's own 60mm mortars.
- c. The 60mm mortars can be used to suppress/screen until another agency can provide fires.

## 2. Call for Fire.

- a. The standard calls for fire will be used by all personnel and attachments.
- b. See Call for Fire Format Card on pages 183–184 and Close Air Support Briefing Form on pages 191–194.

## 3. Priority Targets.

- a. The fire support coordinator (FSC) will designate priority targets.

- b. Subordinate units may request that targets be shifted or a new one be designated.
- c. Final approval of targets is with the FSC.

#### **4. Smoke.**

- a. Normally, screening/obscuration fires, to include 60mm mortars and M203 smoke, must be authorized by the FSC.
- b. The company must give an estimate of the time needed for smoke when it is requested.

#### **5. Illumination.**

- a. Normally, employment of illumination is authorized for day-light marking of targets for aircraft.
- b. Normally, illumination at night must be authorized by the FSC. This includes 60mm mortar illumination, 40mm white star parachutes, and white star parachute pop-ups.

---

# Fire Support Techniques

---

## 1. General Considerations.

- a. Universal times will normally come from the global positioning system or time hacks from high frequency (HF) radio frequencies of 5.000, 10.000, 15.000, 20.000, and 25.000 megahertz (MHz).
- b. Time on target (TOT) is the exact minute at which the first aircraft's bombs will hit the deck. For example, if bombs are to land at 2136, say *TOT is 36*.
- c. Marking with white phosphorus, red phosphorus, and smoke should be timed to impact 30 seconds prior to TOT. Illumination should impact 45 seconds prior to TOT.

## 2. Laser Employment Consideration.

- a. Laser use is normally coordinated by the forward air controller (FAC).
- b. The pilot must be within 30 degrees left or right of the laser line from the FAC to the target before designating laser-guided munitions.
- c. The pilot can be at any aspect from the laser line for marking.
- d. Direct fire will be coordinated by the FAC and company commander using tracers and/or smoke from M203s.

### 3. Procedures for Suppression of Enemy Air Defenses.

- a. Continuous suppression of enemy air defenses (SEAD). Indirect fires impact at -1 minute, -30 seconds, TOT, +30 seconds, or +1 minute.

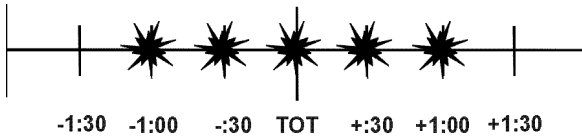

- b. Interrupted SEAD. Indirect fires impact at either -1 minute or -30 seconds.

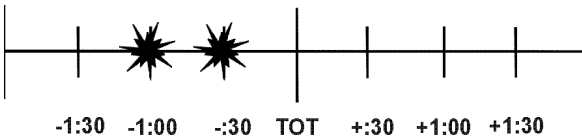

- c. Other combinations of fires must be explicitly delineated on a timeline with TOT being used as zero. For example, to surprise a target using air, the call for fire to the firing agency tells them to mark at -30 seconds and suppression at TOT, +30 seconds, +1 minute, and +1 minute 30 seconds or any other combination. To avoid fratricide, all fires delivered after TOT should be *at my command*.

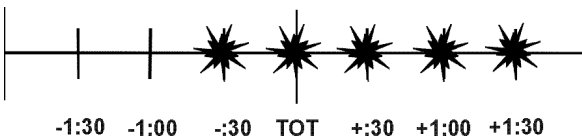

#### **4. Company Fire Support Coordinator Considerations.**

- a. Maintain situational awareness of locations and status of fire support assets and missions. (See the sample Company Fire Support Board on page 167.)
- b. Ensure a forward observer reports both the location of the target and of the company mortar position to the fire support coordination center (FSCC) when employing 60mm mortar during SEAD missions.
- c. Report maximum ordinate of rounds at the range being fired which is taken from the 60mm mortar tabular firing table (whiz wheel).
- d. Coordinate all company direct fires with FAC when using helicopters.
- e. Ensure direct fire information is not passed to FSCC.



# Company Fire Support Board

Our Location _____				TOT _____		
<b><u>Target Suppression Location</u></b>				<b><u>Target Marking Location</u></b>		<b><u>Mark</u></b>
<b>60MM</b> _____						
ISUP	ISMK	FFE	AF	SUPP	SEAD	(Continuous, interrupted, other)
<b>81MM</b> _____						
ISUP	ISMK	FFE	AF	SUPP	SEAD	(Continuous, interrupted, other)
<b>Artillery</b>						
ISUP	ISMK	FFE	AF	SUPP	SEAD	(Continuous, interrupted, other)
<b>Naval Gunfire</b>						
ISUP	ISMK	FFE	AF	SUPP	SEAD	(Continuous, interrupted, other)
<b>Locations</b>						
<b>60s</b>	<b>81s</b>	<b>Artillery</b>	<b>Naval Gunfire</b>			
_____	_____	_____	_____			
_____	_____	_____	_____			
<b>AP/IP</b>	<b>Final attack heading: _____ magnetic azimuth</b>					<b>(circle if applicable)</b>
_____						
<b>60s</b>	_____					
<b>81s</b>	_____					
<b>ARTY</b>	_____					
<b>NGF</b>	_____					
<b>CAS</b>	_____					

# QUICK FIRE SUPPORT PLAN

FIRE PLAN	APPLE	SUPPORTING	3/8	ORIGINATOR	MODIFICATION BY
1240	H-HOUR	SHEET	OF	DATE/TIME	GROUP
TARGET INFORMATION					
	(a)	(b)	(c)	(d)	(e)
LINE	TARGET NO.	DESCRIPTION	LOCATION	ALT ASL M/FT	REMARKS
1		Bunker	420267	160	
2	AD0421	AT Rocket	422260	220	
3	AD3093	OP	421261	180	
4	AD3094	OP	409271	170	
5					
6					

## FRONT

SCHEDULE				
	(f)	(g)	(h)	(i)
LINE	ORG	FIRE UNIT	TIMINGS	REMARKS
1	1/12	B	..... AD3093 48 (a).....	(a) 50% delay 50% VT
2	1/12	B	..... AD3094 48 (a)..... AD3011 48 (a).....	(b) Delay
3			.....	
4			.....	
5			.....	
6			.....	

## BACK

# CALL FOR FIRE ELEMENTS

## 1. Observer Identification.

Example: *You* (call sign), *this is me* (call sign).

## 2. Warning Order.

- a. Type of mission.
  - (1) Adjust fire.
  - (2) Fire for effect.
  - (3) Suppression.
  - (4) Immediate suppression.
  - (5) Suppression of enemy air defenses.
- b. Size of element to fire (optional).
- c. Method of target location.
  - (1) Grid (standard default if method not specified).
  - (2) Polar.
  - (3) Shift from a known point.

## 3. Target Location.

- a. Grid is used for a 6- or 8-digit coordinate (an 8-digit grid preferred).
- b. Polar is used for observer to target direction, distance, and up/down vertical shift (if greater than 30 meters).

- c. Shift used for observer to target direction, left/right lateral shift, add/drop range shift, and up/down vertical shift (if greater than 30 meters).

#### **4. Target Description.**

- a. Type.
- b. Size.
- c. Activity.
- d. Degree of protection.
- e. Shape.

#### **5. Method of Engagement.**

- a. Type of adjustment.
  - (1) Area fire (default).
  - (2) Precision fire (registration or destruction missions).
- b. Danger close (within 600 meters of friendly forces).
- c. Mark.
- d. Trajectory.
  - (1) High angle (default for mortar).
  - (2) Low angle (default for artillery).
- e. Ammunition. High explosive projectile/fuze quick will be used as the default if no other ammunition is specified.
  - (1) Projectiles include—
    - ┆ High explosives (HE).
    - ┆ Antipersonnel (APERS).

- | Improved conventional munitions (ICM).
  - | Illumination (ILLUM).
  - | Tactical riot control agent (CS).
  - | Smoke (SMK).
  - | White phosphorus (WP).
  - | Cannon launched guided projectile (CLGP) (Copperhead).
- (2) Fuzes include—
- | Quick (Q).
  - | Delay (D).
  - | Variable time (VT).
  - | Mechanical time (Ti).
  - | Base detonating (naval gunfire) (BD[NGF]).
- (3) Volume of fire.
- f. Distribution.
- (1) Parallel (default for mortars).
  - (2) Circular (default for artillery).
  - (3) Open.
  - (4) Converged.
  - (5) Special.

**6. Method of Fire and Control (optional).**

- a. Method of fire.
  - (1) One gun in adjust (default).
  - (2) Platoon.
  - (3) Section.
  - (4) Left or right by piece.
- b. Method of control. (Artillery will be fired when it is ready if no other method of control is specified.)
  - (1) At my command.
  - (2) Cannot observe.
  - (3) Time on target (TOT).
  - (4) Close air support TOT.
  - (5) Coordinated illumination.
  - (6) Continuous illumination.

# CALL FOR FIRE PROCEDURES

## 1. Mil Angle Estimation.

When estimating angles in mils with the hand, the arm must be fully extended.

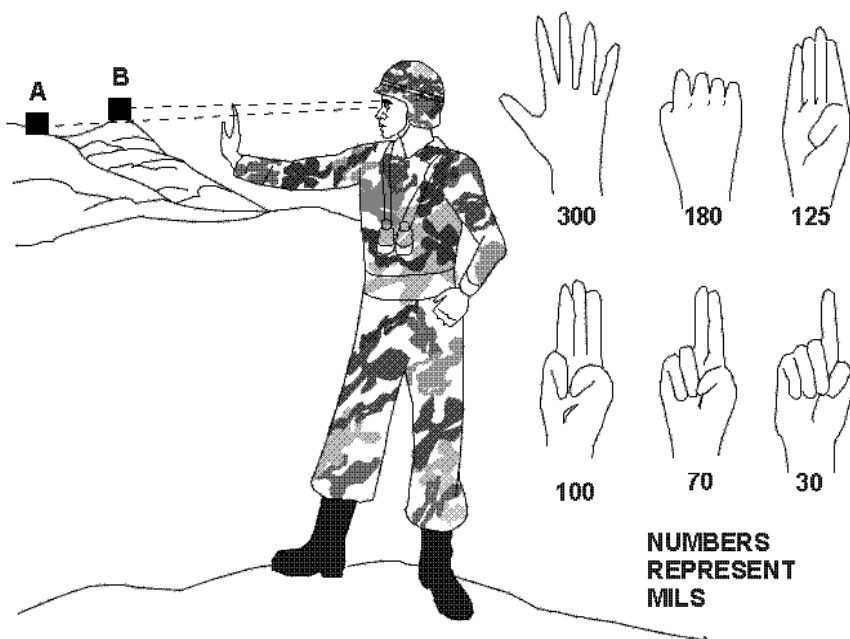

## 2. Target Location Methods.

- a. Grid method is used to determine a 6-digit grid coordinate to the target (8-digit for precision fire).
- b. Polar method is used to—
  1. Determine the observer to target (OT) direction to the nearest 10 mils (always a 4-digit number).

- 1 Determine the OT distance to the nearest 100 meters.
- 1 Determine the OT vertical difference in altitude to the nearest 5 meters (sent as *up* or *down* if 35 meters or greater).
- c. Shift method is used to—
  - 1 Identify the known point to be used.
  - 1 Determine the OT direction.
  - 1 Determine the left or right lateral shift (W) from the known point to the target (express to the nearest 10 meters).
    - W = SF (shift factor) x M (number of mils between known point and target).
    - SF = Range to the known point divided by 1,000 (expressed to the nearest 10th).
    - M = Measured angle in mils between the known point and the target.
  - 1 Determine the add/drop range shift from the known point to the target to the nearest 100 meters.
  - 1 Determine the up/down vertical difference in altitude between the known point and the target only if the difference is 35 meters or greater; express to the nearest 5 meters.

### 3. Call for Fire Examples.

- a. The following table lists types of missions and examples of calls for fire for each.



<b>Mission Type</b>	<b>Call for Fire Examples</b>	<b>Notes</b>
Grid	A1D de L2P FFE <i>k</i> Grid 487624 <i>k</i> 2 T-72s in open, ICM <i>k</i>	Direction must be sent prior to first correction.
Polar	A1D de L2P AF Polar <i>k</i> Dir 5340, Dist 1200, Up 70 <i>k</i> Two PMPs in the open <i>k</i>	Fire direction center must have forward observer location to use polar mission.
Shift	A1D de L2P AF Shift AB3001 <i>k</i> Dir 4800, R250, Add 400, Down 95 <i>k</i> Company assembly area <i>k</i>	Both fire direction center and forward observer must have known point location.
Note: <i>k</i> means over		

- b. A Call for Fire Format Card sample is shown on pages 183–184.

#### 4. Smoke Employment.

<b>Delivery System</b>	<b>Type of Round</b>	<b>Average Burn Time</b>	<b>Average Obscuration Length (Meters)/Round</b>	
			<b>Crosswind</b>	<b>Head/Tailwind</b>
155mm	HC WP M825	4 min 1–1.5 min 5–8 min	350 150 350	75 50 100–200
105mm	HC WP	3 min 1–1.5 min	250 75	50 50
81mm	WP RP	1 min 1.5–2 min	100 90–150	40 40–50
60mm	WP	1 min	75	40
5"/54	WP	1 min	150	40

## 5. Immediate Smoke.

- a. Immediate smoke—
  - 1 Obscures, protects, or marks smoke over small area.
  - 1 Is more responsive, but the duration and coverage of the smoke is limited.
- b. Elements of the call for fire sent in one transmission are as follows:
  - 1 Observer identification.
  - 1 Warning order.
  - 1 Target location is normally directly on the target.
  - 1 Authentication of the transmission.
- c. Example call for immediate smoke: *W5S this is HZD, immediate smoke, grid 487624, I authenticate INDIA KILO, over.*

## 6. Message to Observer.

- a. After the fire direction center receives the call for fire, the fire direction officer will determine how the target will be attacked.
- b. The attack decision is announced to the forward observer in the form of a message to observer (MTO).
- c. The forward observer will read the MTO back to the fire direction center to ensure confirmation.
- d. The MTO consists of the following elements:
  - 1 Unit to fire for effect.
  - 1 Any changes to requests in the call for fire.
  - 1 Method of fire (number of rounds to be fired).
  - 1 Target number.

- e. Example of an MTO: *W3D DE D2H MTO, D, ICM, three rounds, AB1001, over.*

## **7. Corrections.**

- a. After the initial round is fired, the forward observer transmits subsequent corrections until the mission is terminated.
- b. The order subsequent corrections are transmitted are as follows:
  - | Direction.
  - | Danger close.
  - | Trajectory.
  - | Method of fire.
  - | Distribution.
  - | Projectile.
  - | Fuze.
  - | Volume of fire.
  - | Deviation.
  - | Range.
  - | Height of burst.
  - | Target description.
  - | Change in type mission control.
  - | Splash.
  - | Repeat.

## 8. Deviation Corrections.

- a. The left or right deviation correction is determined by multiplying, in mils, the deviation between impact and the target (the deviation spotting) by the OT factor. Deviation corrections are expressed to the nearest 10 meters.

$$\begin{array}{l} \text{Left or right deviation} \\ \text{correction in meters} \end{array} = \begin{array}{l} \text{Deviation spotting} \\ \text{(to nearest 5 mils)} \end{array} \times \begin{array}{l} \text{OT} \\ \text{factor} \end{array}$$

- b. A deviation correction less than 30 meters is considered minor and is ignored during the mission.
- c. The OT factor is the expressed distance from the forward observer to the target in meters divided by 1,000.

$$\text{OT factor} = \frac{\text{Expressed OT distance}}{1000}$$

- d. If an OT distance is greater than 1,000 meters, express the distance to the nearest thousand meters. If an OT distance is less than 1,000 meters, express the distance to the nearest hundred meters. For example:

The OT distance is 1,500 meters, which is expressed as 2,000 meters.

Deviation spotting is L45.

$$\text{OT factor} = \frac{2000}{1000} = 2$$

The deviation correction = 45 x 2 = 90 meters. The deviation correction is R90.

The OT distance is 650 meters, which is expressed as 600 meters.

Deviation spotting is R60 mils.

$$\text{OT factor} = \frac{600}{1000} = .6$$

The deviation correction = 60 x .6 = 36 meters, which expresses to 40 meters.

## 9. Range Corrections.

- a. Range corrections consist of the commands **add** (move burst away from observer) and **drop** (move burst closer to the observer).
- b. Range corrections are transmitted in multiples of 100 meters; 50-meter corrections may be used when entering fire for effect.
- c. Range correction methods.
  - (1) Successive bracketing.
  - (2) Hasty bracketing.
  - (3) One-round adjustment.
  - (4) Creeping fire (used during danger close missions; not corrections greater than 100 meters).
- d. Minimum bracketing guide.

OT Distance	Initial Bracket
0–100 meters	100 meters
1000–2000 meters	200 meters
2000 meters and beyond	400 meters

## 10. End of Mission Statement.

- a. Refinement (optional).
- b. Record as target (optional).
- c. End of mission.
- d. End of surveillance (to include battle damage assessment).
- e. Example end of mission statement: ***R10, +30, record as target, end of mission, target neutralized, estimate 5 casualties, over.***



SPOTTINGS			CORRECTIONS			OT DISTANCE - OT FACTOR:	
RNG	DEV	HOB	L/R	+/-	U/D	RND #	NOTES

**BACK**

# CLOSE AIR SUPPORT

---

## Close Air Support Control Procedures

---

### 1. General Considerations.

Typically, close air support (CAS) briefings are presented in the “9-line brief” format. (See pages 191–194.) This format is used when detailed coordination is required. However, if Marines need immediate air support and they are unfamiliar with the 9-line brief, they should establish communication with the aircraft and then talk it on to the target. Appendix K provides a description of CAS aircraft capabilities.

### 2. Air Support Requests.

Air support can be requested from either the direct air support center (DASC) or from the air officer in the fire support coordination center (FSCC). Immediate air support is normally requested from the DASC via the tactical air request net (high frequency [HF]). Communications may be established with the DASC on the tactical air traffic control net, tactical air direction (TAD) net, or direct air support net. Marines must also establish a location and frequency (TAD net) for the aircraft to contact them. If UHF/VHF communications have not been established, tactical air control party (TACP) (FM) nets can be used. If unable to contact the DASC, communications are established with the FSCC via any available net. Since the



DASC and the FSCC are normally linked, contact with the FSCC will allow contact with the DASC's air officer. Marines need to provide either the DASC or the FSCC with the following information:

- | Who they are.
- | Where they are.
- | What they need.

### 3. Terminal Control.

Once communication is established with the supporting aircraft, the pilot must acquire the target as quickly as possible since the aircraft will have limited time on station. The requesting unit must facilitate the pilot's acquisition of the target by providing the following information.

- a. Reference large areas/objects that the pilot will be able to see and then work down to smaller areas/objects.

Requesting unit: *See the road you are circling over? Okay. Follow that road north for about eight clicks and you will see a prominent hill mass just to the east of the road. I am located on the north side of the hill. Friendlies are generally located to my south and west and the bad guys are on the east side of the road and to my north.*

- b. Reference the exact position in order to orient the pilot.

Requesting unit: *From my position you will see an open area to my immediate north and a deep draw that runs to the east out of the open area. There is an enemy platoon dug in on the finger that is just north of the draw. Do you see that?*

- c. Continue to develop the situation as required. The pilot knows where the friendly forces are located and could potentially engage the target at this time. Pass any other pertinent information that would be helpful to the pilot.

Requesting unit: *There are a couple of heavy machine gun vehicles in the treeline on the northern edge of the clearing. Request that you engage these first and then the infantry. Call me rolling in with your direction of attack.*

- d. Wait for the pilot to assimilate all the information and formulate the plan of attack.

Pilot: *I am rolling in from the southeast, about five miles from your position . . . wings level.*

Requesting unit: *Cleared hot.*

“Wings level” means that the pilot is ready to drop bombs on the target and is waiting for permission. Permission is indicated by a “cleared hot” from the requesting unit. Before a unit gives permission to the aircraft, it must ensure that the aircraft is pointed at the target area and not at the requesting unit.

- e. Provide any corrections to the second aircraft (the wingman) after the first aircraft (lead) drops its bombs.

Requesting unit: *From lead's hits, east 100 meters.*

- f. Instruct the aircraft to re-attack the target and continue to give refinements.

Requesting unit: *You are cleared for an immediate re-attack. From dash two's hits, northeast 200, try to hit the top of finger.*

- g. Continue to control the aircraft in this fashion until they are “bingo,” which means they are out of fuel and must leave.
- h. Provide a detailed debrief on what the aircraft destroyed and if it was effective.

---

## Close Air Support Briefing Form

---

If a significant surface threat to the aircraft does not exist, a general situation brief and target location may be all that is required for the aircraft to engage the target. If the briefing format is used, pass the brief in a slow, concise manner and “unkey” the radio after every three lines for a couple of seconds.

Aircraft check-in procedures are extremely important to establish the flow of information between aircraft and controllers. The close air support (CAS) check-in briefing format is used when checking in with terminal controllers.

The CAS briefing form (9-line briefing form) shown on page 191 is used to pass data to the pilot. A typical 9-line brief for a fixed-wing aircraft’s CAS mission might sound as follows:

*Georgia, 315 left, 7.5. . . . 750, 4 BMPs on road, TP 011798. . . .  
WP, SW 1400, egress east then south to Kentucky. . . . ZSU 23-4  
2000 meters north of target. Final attack heading 360-030. . . .  
Time on target 25.* If the aircraft understood all that you said  
and doesn’t have any questions, you would hear: **Roger 25.**



Omit data not required; do not transmit line numbers. Units of measure are standard unless otherwise specified.

\*Denotes minimum essential information required in a limited communication environment. **Bold** denotes readback items when requested.

Terminal controller: " \_\_\_\_\_, this is \_\_\_\_\_ "  
(aircraft call sign) (terminal controller)

\*1. **IP/BP**: " \_\_\_\_\_ "

\*2. Heading: " \_\_\_\_\_ " (magnetic). "Offset \_\_\_\_\_ (left/right)"

\*3. Distance: " \_\_\_\_\_ "

\*4. Target elevation: " \_\_\_\_\_ " (in feet MSL)

\*5. Target description: " \_\_\_\_\_ "

\*6. **Target location**: " \_\_\_\_\_ "  
(latitude/longitude or grid coordinates or offsets or visual)

7. Type mark: " \_\_\_\_\_ " Code: " \_\_\_\_\_ "  
(WP/laser/IR/beacon) (actual code)  
Laser to target line: " \_\_\_\_\_ degrees"

\*8. **Location of friendlies**: " \_\_\_\_\_ "

Position marked by: " \_\_\_\_\_ "

9. "Egress \_\_\_\_\_ "

-----  
Remarks (as appropriate): " \_\_\_\_\_ "

(Threats, Hazards, Weather, Restrictions, Ordnance Delivery, Attack Heading, Danger Close, SEAD)

Time on target: "TOT \_\_\_\_\_ "

OR

Time to target: "Stand by \_\_\_\_\_ plus \_\_\_\_\_ . . . Hack."

## CAS Briefing Form (9-Line Briefing Form)

Line 1. IP/BP. Initial point is used for fixed-wing aircraft. It is the 5–15 nautical mile run-in to the target. A battle position is used for rotary-wing aircraft. It is 3,000–5,000 meters from the target. It is a large area (1000 x 1000 m or >) from which a rotary-wing aircraft engages the target. In some instances, an informal airspace coordination area (ACA) may have to be established to allow the rotary-wing aircraft to run-in closer (500–1500 meters) to the target.

Line 2. Heading. The heading is given in degrees magnetic from IP (or center of the BP) to the target. The Offset (left or right) indicates the side of the IP to target line that aircrews can maneuver in while in the target area. Saying *degrees magnetic* after the number is not necessary—degrees magnetic is understood.

Line 3. Distance. The distance from the IP/center of the BP to the target. It is given in nautical miles to the nearest tenth (e.g., 12.3 nautical miles) to fixed-wing aircraft and in meters to the nearest hundred (e.g., 3200 meters) for rotary-wing aircraft. Saying *nautical miles* after the number is not necessary—nautical miles are understood.

Line 4. Target elevation. The target elevation is given in feet above mean sea level. If the map contour interval is in feet, take the elevation directly from the map. If the map contour is in meters, convert it to feet.

Line 5. Target description. The target description contains the number, type of target, and degree of protection. It is a brief, concise description of the target. It includes target activity and configuration that may assist its identification. For example, *4 APCs on road, stationary. . . . Bunker complex. . . . Tank column in open, moving north to south.*

Line 6. Target location. The target location is a 6-digit grid coordinate. Target location can be given as a UTM grid coordinate or as latitude and longitude. Any Marine Corps CAS aircraft can accept a UTM grid coordinate.

Line 7. Type mark. The type of mark used: e.g., WP (white phosphorus), RP (red phosphorus), laser (include 4-digit code), illumination on the deck, HE, mirror flash. If no mark is available, the pilot is guided onto the target using available references (e.g., roads, streams, open areas, prominent terrain).

Line 8. Location of friendlies. Cardinal direction (north, south, east, west) and distance (in meters) from the target to the nearest friendly position, which is frequently the forward air controller's position. Example: *SW 1500*.

Line 9. Egress. Instructions the aircraft will follow to exit the target area after engaging the target. It includes direction to turn out of the target area and a control point to which the aircraft will fly. Use the word "Egress" before giving egress instructions. Example: *Egress east, then south to Georgia*.

Remarks. If applicable, additional threats, hazards, weather, final attack heading, artillery gun target lines, etc., can be given here.

Time on target. Time on target (TOT) is the synchronized, universal clock time when ordnance will hit the target. There is no time "HACK" for TOT. TOT is the preferred towing method. The Naval Observatory (DSN 762-1401) or a global positioning system (GPS) can provide a common time reference. If neither is available, the terminal controller can still execute a TOT mission by synchronizing time using a watch as a reference. It is passed to the aircraft as a number of minutes past the hour (e.g., 1624 would be 24 and communicated as *Time on target 24*).



Time to target. Time to target (TTT) is the number of minutes and seconds after the “HACK” that ordnance will hit the target (e.g., 4 minutes would be passed as 4 plus 00). Immediately after the minutes and seconds are passed, *HACK* is said. The pilot punches a stopwatch in the aircraft and prepares to put bombs on the target at the requested time. Example: *Stand by for the time to target. . . . Time to target 4 plus 00. . . . HACK.*

*Note: “HACK” indicates that all participants start the countdown.*

Amplifying remarks. Anything else that is pertinent to the mission must also be passed to the pilot. If a further explanation of the target area will assist the pilot in locating the target, that information is passed after the TOT/TTT has been passed. There is no format for this information. Communicate with the pilot using plain language.

## Appendix A

# Machine Gun Employment

### 1. General Considerations.

- a. Type of support.
  - (1) General support.
  - (2) Direct support.
  - (3) Attached.
- b. Mission statement.
  - (1) Suppress.
  - (2) Neutralize.
  - (3) Destroy.
- c. Offensive employment.
  - (1) Close support fires.
  - (2) Long-range fires.
  - (3) Flank protective fires.
  - (4) Fires in support of consolidation.
- d. Defensive employment.
  - (1) Final protective lines (FPL).
  - (2) Principle direction of fire (PDF).

- e. Tactical employment considerations.
  - (1) Pairs.
  - (2) Interlocking fires.
  - (3) Coordination of fires.
  - (4) Mutual support.
  - (5) Defilade.
  - (6) Enfilade.
  - (7) Protection.

## **2. Range Cards.**

- a. A range card is a rough terrain sketch that serves two purposes.
  - (1) Record of firing data.
  - (2) Document for defensive fire planning.
- b. Two copies are prepared.
  - (1) One copy is passed up the chain of command to assist in the preparation of the unit's fire plan sketch.
  - (2) The other copy stays with the gun(s) to assist in the potential turnover of a firing position to another gun team.
- c. Walking the FPL.

- (1) Walk whenever practical and after the machine guns are set in firing positions to cover assigned sectors of fire.
- (2) Conduct to ascertain the extent of grazing fire and dead space (the latter must be noted on the range card and covered by another weapon system).
- (3) Follow the steps below when walking the dead space:
  - The gunner places himself behind the gun, sets his sight on the limit of grazing fire (600 meters for M240G and 1,000 meters for M2), and lays the gun on an aiming point 600 (or 700) meters distant along the FPL.
  - The team leader walks the FPL using a standard measured pace.
  - When the team leader drops off into a space where the gunner can no longer see him from the shoulder down, the gunner signals “mark” either by hand and arm signals or by tugging on a line the team leader has in his hand. When the team leader reappears, a second tug or signal is given. When there is no more grazing fire, a signal is given and the team leader returns.
  - The team leader records on his pace card the number of paces he has covered to each point. This is continued until the team leader reaches the limit of grazing fire for the weapon.
  - This information is then incorporated into the range card (samples follow).

(4) Machine gun range card (PDF).

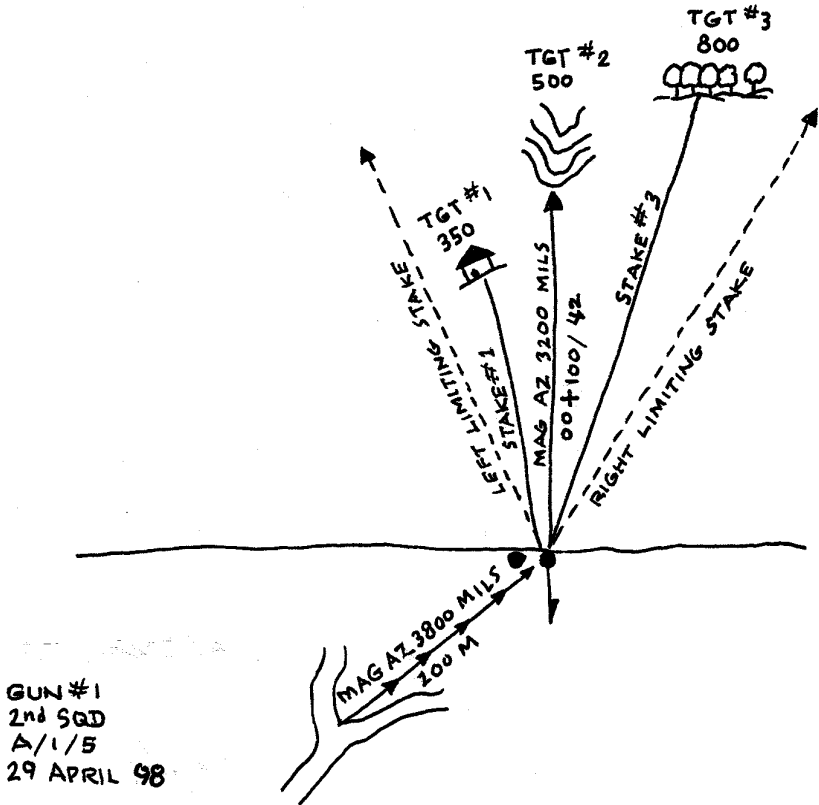

(5) Machine gun range card (FPL).

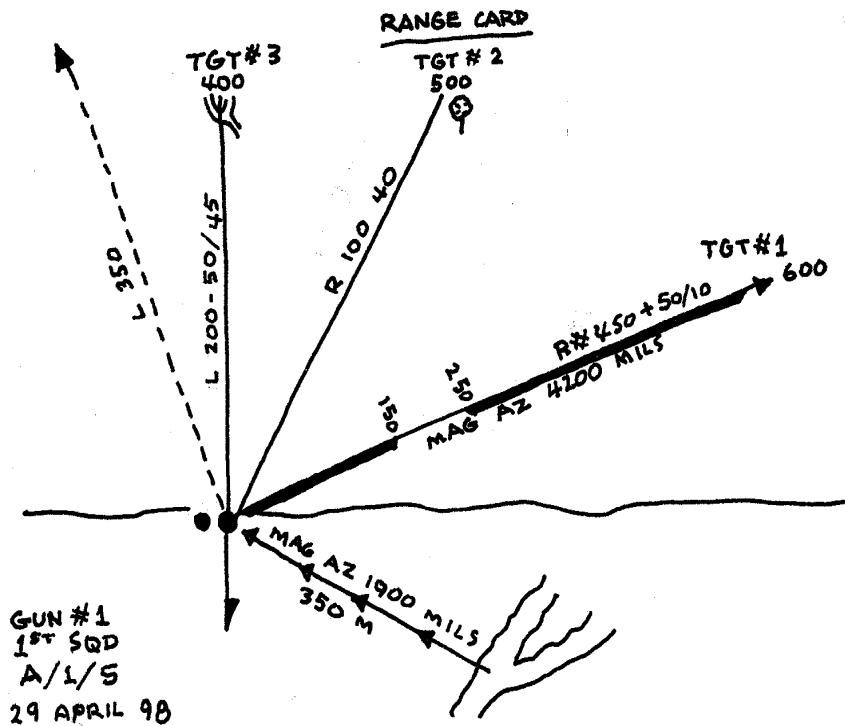

### 3. Machine Gun Emplacements.

- a. Horseshoe type machine gun emplacement.

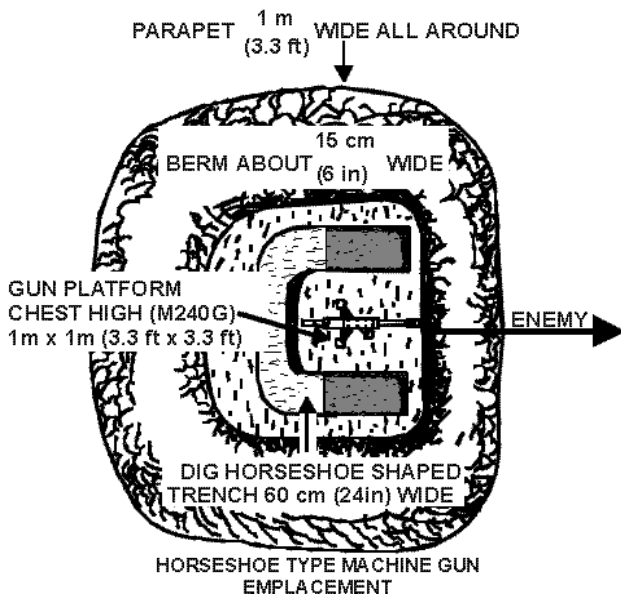
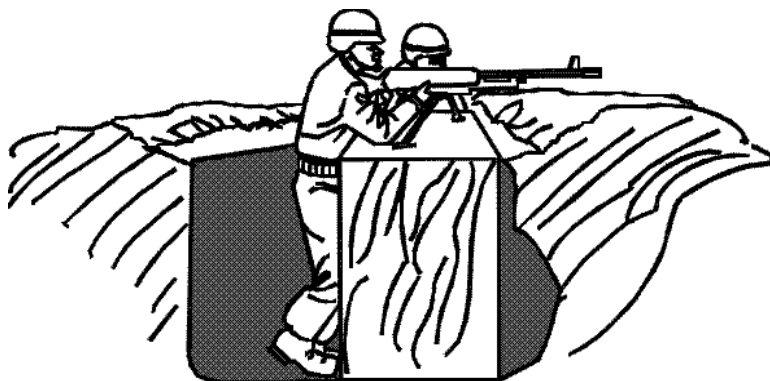

- b. "T"-shaped firing position.
  - (1) Firing primary sector.

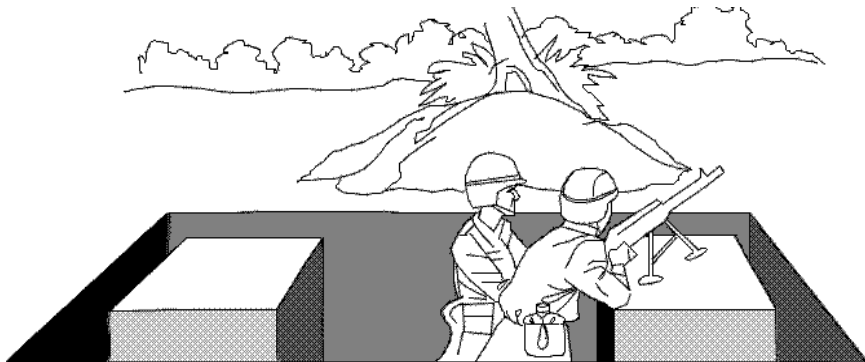

- (2) Firing secondary sector.

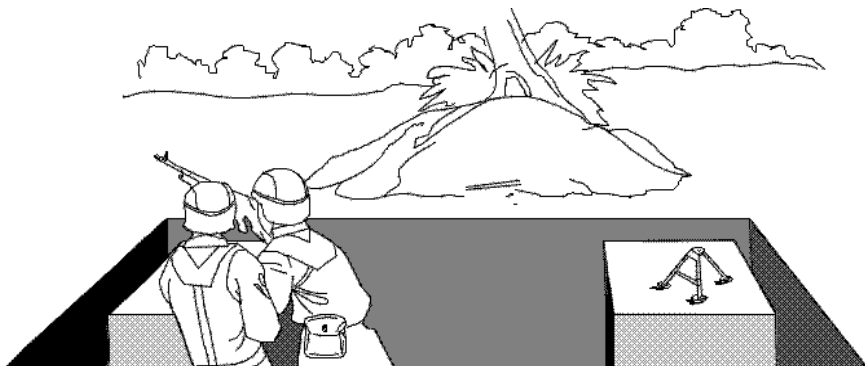



## Appendix B

### Weapons Handling

Weapons handling procedures provide a consistent and standardized way for a Marine to safely and confidently load, unload, and employ individual small arms during training and combat.

#### 1. Safety Rules.

These rules apply to all weapons at all time and must never be violated.

**Rule 1—Treat every weapon as if it were loaded.**

**Rule 2—Never point a weapon at anything you do not intend to shoot.**

**Rule 3—Keep finger straight and off the trigger until you are ready to fire.**

**Rule 4—Keep weapon on *SAFE* until you intend to fire.**

#### 2. Weapons Conditions Codes.

A weapon's readiness and safety status is described by one of four conditions. The steps in the loading and unloading process take the weapon through four specific conditions that indicate the weapon's readiness for live fire. Always clear a weapon before placing it into **condition 4**. Always clear a weapon if the firer is not sure what condition the weapon is in and after **condition 1** prior to going back into any other condition.

- a. General weapons condition codes.

**Condition 1**—Ammunition must be in a position to be fired, the safety must be engaged.

**Condition 2**—Ammunition must be in position to be fired, the weapon's action must be closed, the hammer must be forward. (This condition only applies to weapons that have single-action external hammers.)

**Condition 3**—Ammunition is in position to be chambered, the chamber is empty, the action is closed, the safety is on (off for M249s and M240Gs).

**Condition 4**—All ammunition is removed, the chamber is empty, the action is closed, the safety is on (off for M249s and M240Gs).

- b. M9 9mm pistol condition codes.

**Condition 1**—The weapon is loaded and ready to fire, magazine is inserted, round is in the chamber, the hammer is not cocked, the ambidextrous safety is on.

**Condition 2**—Not applicable to the M9 pistol.

**Condition 3**—The slide is forward on an empty chamber, ambidextrous safety is on with a full magazine loaded in the weapon.

**Condition 4**—The magazine is removed, pistol is free of ammunition, slide is forward on an empty chamber, ambidextrous safety is on.

- c. M16A2 rifle condition codes.

**Condition 1**—Magazine is inserted, round is in the chamber, bolt is forward, weapon is on *SAFE*.

**Condition 2**—Not applicable to the M16A2.

**Condition 3**—Bolt is forward on an empty chamber, loaded magazine is in, safety is on.

**Condition 4**—Magazine is out, bolt forward on an empty chamber, safety is on.

- d. M249 squad automatic weapon (SAW) condition codes.

**Condition 1**—Ammunition is in position on the feed tray (or magazine is inserted), bolt is to the rear, safety is on.

**Condition 2**—Not applicable to the M249.

**Condition 3**—Ammunition is in position on the feed tray (or magazine is inserted), chamber is empty, bolt is forward, safety is off.

**Condition 4**—Feed tray is clear of ammunition (magazine is removed), chamber is empty, bolt is forward, safety is off.

### 3. Commands.

<i>Unload</i>	Clear the weapon and place the weapon in <b>condition 4</b> .
<i>Load</i>	Place the weapon in <b>condition 3</b> .
<i>Make ready</i>	Place the weapon in <b>condition 1</b> .
<i>Fire</i>	Engage targets.

*Cease fire*

Stop firing.

*Unload, show clear*

Allow the chamber to be checked by a second individual prior to going to **condition 4**.

#### **4. Unload Execution.**

To execute *unload*, taking the weapon from **condition 1** to **condition 4** (belt-fed technique), perform the following steps:

- | Take the weapon off of *SAFE*.
- | Pull the cocking handle to the rear.
- | Put the weapon on *SAFE*.
- | Open the feed tray cover.
- | Remove all ammunition and belt links.
- | Lift the feed tray and inspect the chamber to ensure that no ammunition is present.

## Appendix C

### Nuclear, Biological, and Chemical Defense

#### 1. Warning.

The battalion's primary means of control of unit nuclear, biological, and chemical (NBC) defense is the NBC Warning and Reporting System. This system prescribes basic defensive procedures to follow during stated conditions and is based on progressive phases of NBC alerts.

- a. Condition white: all clear.
- b. Condition yellow: attack imminent.
- c. Condition red: actual attack.

#### 2. NBC Markers.

- a. Known contaminated areas are marked to indicate a hazard as shown in the following figure.
- b. The written marker side is positioned to be read by anyone entering the area.

**CHEMICAL**  
(RED INSCRIPTION ON  
YELLOW TRIANGLE)

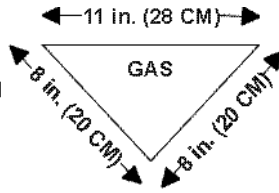

(AGENT)  
(DATE)  
(TIME)

**BIOLOGICAL**  
(RED INSCRIPTION ON  
BLUE TRIANGLE)

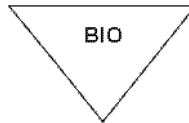

(AGENT)  
(DATE)  
(TIME)

**RADIOLOGICAL**  
(BLACK INSCRIPTION ON  
WHITE TRIANGLE)

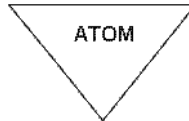

(DOSE RATE)  
(DATE)  
(TIME)  
(BURST TIME)  
(BURST DATE)

**CHEMICAL  
MINEFIELD**  
(UNEXPLODED MINES)  
(YELLOW INSCRIPTION ON RED  
TRIANGLE WITH YELLOW STRIPE)



(OPTIONAL)  
(TYPE OF AGENT)  
(DATE EMPLACED)

**BOOBYTRAP**  
(RED TRIANGLE WITH  
WHITE STRIPE)

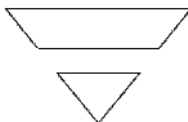

**UNEXPLODED  
MUNITION**  
(RED TRIANGLE WITH  
WHITE BOMB)

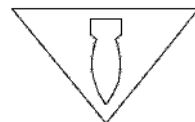

### 3. Required Reports.

The NBC Warning and Reporting System includes the chemical downwind message and the required reports.

- a. NBC 1, Observer's Report (details of an attack) is sent as a FLASH priority message.

BRAVO	Position of observer.
CHARLIE	Direction of attack from observer.
DELTA	Date-time group of attack.
ECHO	Illumination time or length of attack.
FOXTROT	Location of attack.
GOLF	Means of delivery.
HOTEL	Type of burst or agent/height of burst.
JULIETT	Flash to bang time.
KILO	Crater diameter.
LIMO	Nuke burst cloud angle width (5 minutes after burst only).
MIKE	Cloud top or bottom angle or height at $H + 10$ .

- b. NBC 2, Evaluated Data Report.

ALFA	Strike serial number.
DELTA	Date-time of the attack.
FOXTROT	Location of attack.

GOLF	Means of delivery.
HOTEL	Type of burst.
NOVEMBER	Estimated yield.
YANKEE	Downwind direction of hazard.
ZULU	Effective windspeed/downwind distance of zone 1.

c. NBC 3, Immediate Warning of Expected Contamination Report.

ALFA	Strike serial number.
DELTA	Date-time of attack.
FOXTROT	Location of attack.
HOTEL	Type of burst or agent/height of burst.
NOVEMBER	Estimated yield.
ROMEO	Area of expected contamination.
YANKEE	Downwind direction of hazard.
ZULU	Effective windspeed/downwind distance of zone 1.

d. NBC 4, Monitoring and Survey Results Report.

QUEBEC	Location of reading.
ROMEO	Dose rate.
SIERRA	Date-time of reading.





	<b>Nerve</b>		<b>Blister</b>	<b>Blood</b>	<b>Choking</b>
<b>Dissemination</b>	Aerosol or vapor	Liquid droplets	Liquid droplets	Vapor (gas)	Vapor (gas)
<b>Rate of action</b>	Very rapid by inhalation; slow through skin.	Delayed through skin; more rapid through eyes.	Blistering delayed hours to days; eye effects more rapid. Mustard, lewisite, and phosgene oxime very rapid.	Rapid.	Immediate to 3 hours.
<b>First aid</b>	Give nerve agent antidote injection. Artificial respiration may be necessary.		None.	Artificial respiration may be necessary.	For severe symptoms, avoid movement; keep warm.
<b>Decontamination</b>	None.	Flush eyes with water; decontaminate skin with M258 kit.	Flush eyes with water; decontaminate skin with M258 kit or wash with soap and water.	None.	None.
<b>Protection</b>	Protective mask; protective clothing.		Protective mask; protective clothing.	Protective mask.	Protective mask.

**5. MOPP Levels Before Chemical Attack.**

<b>MOPP Level</b>	<b>Over-Garment</b>	<b>Over-Boots</b>	<b>Mask with Hood</b>	<b>Gloves</b>
1	Worn open or closed based on temperature	Carried	Carried	Carried
2	Same as MOPP-1	Worn	Carried	Carried
3	Same as MOPP-1	Worn	Worn hood open or closed based on temperature	Carried
4	Worn closed	Worn	Worn hood closed	Worn

**6. Selective Unmasking Procedure.**

- a. Select and disarm two or three Marines to test.

- b. Take a deep breath and break seal for 15 seconds with eyes open.
- c. Remask, clear and check the mask.
- d. Wait in the shade for 10 minutes and check Marines for symptoms.
- e. Break seal and take two or three breaths.
- f. Remask, clear and check mask.
- g. Wait in the shade for 10 minutes and check Marines for symptoms.
- h. Unmask in the shade for 5 minutes.
- i. Remask for 10 minutes.
- j. Check Marines for symptoms.
- k. If no symptoms have appeared, have all Marines unmask.

## Appendix D

# Communications and Information Systems

### 1. General Rules for Radio Use.

- a. Listen before transmitting.
- b. Avoid excessive tuning and testing.
- c. Ensure message is clear, concise, premeditated, and, if possible, previously written.
- d. Speak clearly, slowly, in natural phrases, and enunciate each word. If the receiving operator must write, allow sufficient time for writing.
- e. Assume the enemy is always listening.
- f. Notify higher headquarters using an alternate means of communications if jamming occurs. After jamming stops, send a meaconing, intrusion, jamming, interference (MIJI) report.
- g. Maintain whip antennas in a vertical position.
- h. Ensure the vehicle-mounted radio is turned off before starting the vehicle.
- i. Communicate directly with other leaders on the net (if possible) if the unit is in contact with the enemy. Also, communicate directly with other leaders when asking for clarification or explaining a situation.

**2. Message Handling Time.**

- a. The following time objectives apply as a general guide. They include overall handling time from the point of origin to delivery to the addressees at the point of destination.

<b>Precedence Category</b>	<b>Time Standards</b>
Flash	Not fixed. Handled as fast as humanly possible; objective is less than 10 minutes.
Immediate	10 minutes to 1 hour.
Priority	1 to 6 hours.
Routine	3 hours to start of business the following day.

- b. When taking and delivering messages via voice communications, the use of “yellow canary” message types increase speed and accuracy.

**3. Field Expedient Antennas.**

- a. Operators use field expedient antennas to—
  - ┆ Replace a damaged antenna.
  - ┆ Increase the distance of their radio’s signal.
  - ┆ Concentrate the radio’s signal in a particular direction.
- b. The most common element used to construct a field expedient antenna is WD-1 communications wire, but other materials can be used (e.g., barbed wire, metal fences, bed springs, metal posts, metal windows, other types of electrical wire).

- c. Formulas for constructing field expedient antennas using WD-1 type communications wire are shown in the following table:

<b>Calculate Wire Lengths in Feet</b>	
<b>Wavelength</b>	<b>Formula</b>
Quarter wave length	$\frac{225.5}{44.80 \text{ MHz}} = 5.03 \text{ feet or } 5 \text{ feet } 3/8 \text{ inches}$
Half wave length	$\frac{451}{57.35 \text{ MHz}} = 7.86 \text{ feet or } 7 \text{ feet } 10 \text{ } 1/3 \text{ inches}$
Full wave length	$\frac{902}{65.85 \text{ MHz}} = 13.7 \text{ feet or } 13 \text{ feet } 8 \text{ } 3/8 \text{ inches}$

- d. Wire length can also be computed using the quick reference antenna length chart on page D-4 and D-5.
- e. When measuring wire for the antenna, the length may have to be approximated. If a tape measure or some other measuring device is not available, cut the wire 6 to 12 inches over the length derived from the formula. This will ensure a complete half wave or full wave.
- f. Some field expedient antennas are constructed using the following insulators:

<b>Best</b>	<b>Good</b>	<b>Last Choice</b>
Plastic	Wood	Cloth/rope
MRE spoon	Stick	550 cord
MRE pouch	Tree bark	Rags

- g. Once the antenna material is connected to the radio at the antenna mount with wire, begin transmitting.

HF			VHF		
Operating Frequency in MHz	1/2 Wave	1 Wave	Operating Frequency in MHz	1/2 Wave	1 Wave
2	225' 6"	451'	30	15' 3/8"	30' 7/8"
3	150' 4"	300' 8"	32	14' 1-1/8"	28' 2-1/4"
4	112' 9"	225' 6"	34	13' 3-1/8"	26' 6-3/8"
5	90' 2-3/8"	180' 4-3/4"	36	12' 6-3/8"	25' 3/4"
6	75' 2"	150' 4"	38	11' 10-3/8"	23' 8-7/8"
7	64' 5"	128' 10-1/3"	40	11' 3-3/8"	22' 6-5/8"
8	56' 4-1/2"	112' 9"	42	10' 7-7/8"	22' 5-3/4"
9	50' 1-3/8"	100' 2-2/3"	44	10' 3"	20' 6"
10	45' 1-1/4"	90' 2-3/8"	46	9' 9-5/8"	19' 7-3/8"
11	41'	82'	48	9' 4-3/4"	18' 9-1/2"
12	37' 7"	75' 2"	50	9' 1/4"	18' 1/2"
13	34' 8-1/4"	69' 4-1/2"	52	8' 8"	17' 4-1/4"
14	32' 2-1/2"	64' 5-1/8"	54	8' 4-1/4"	16' 3-3/8"
15	30' 7/8"	60' 1-7/8"	56	8' 5/8"	16' 1-2/3"
16	28' 2-1/4"	56' 4-1/2"	58	7' 9-3/8"	15' 6-5/8"
17	26' 6-3/8"	53' 3/4"	60	7' 6-1/4"	15' 3/8"
18	25' 3/4"	50' 1-1/3"	62	7' 3-1/4"	14' 6-5/8"
19	23' 8-7/8"	47' 5-5/8"	64	7' 5/8"	14' 1-1/8"

20	22' 6-5/8"	45' 1-1/4"	66	6' 10"	13' 8"
21	21' 5-3/4"	42' 11-3/8"	68	6' 7-5/8"	13' 3-1/8"
22	20' 6"	41'	70	6' 5-1/4"	12' 10-5/8"
23	19' 7-3/8"	39' 2-2/3"	72	6' 3-1/8"	12' 6-3/8"
24	18' 9-1/2"	37' 7"	74	6' 1-1/8"	12' 2-1/4"
25	18' 1/2"	38' 1"	76	5' 11-1/8"	11' 10-3/8"
26	17' 4-1/4"	34' 8-1/4"	78	5' 9-3/8"	11' 6-3/4"
27	16' 8-3/8"	33' 4-7/8"	80	5' 7-2/3"	11' 3-3/8"
28	16' 1-1/3"	32' 2-1/2"	82	5' 6"	11'
29	15' 6-5/8"	31' 1-1/4"	84	5' 4-3/8"	10' 8-7/8"
30	15' 3/8"	30' 7/8"	86	5' 2-7/8"	10' 5-7/8"

#### 4. Sloping Wire Antenna.

- a. Cut a wire to the required length (see the quick reference antenna length chart above or use the antenna length formula on page D-3).
- b. Attach insulator to one end of the wire. Attach the other end of the wire to the antenna connector on the radio.
- c. Tie a rope to the insulator end. Throw the rope over a tree limb. See figure on page D-6.
- d. Pull the rope up. Make sure there is enough slack to form a slope. Take the radio and move in the direction of transmission.



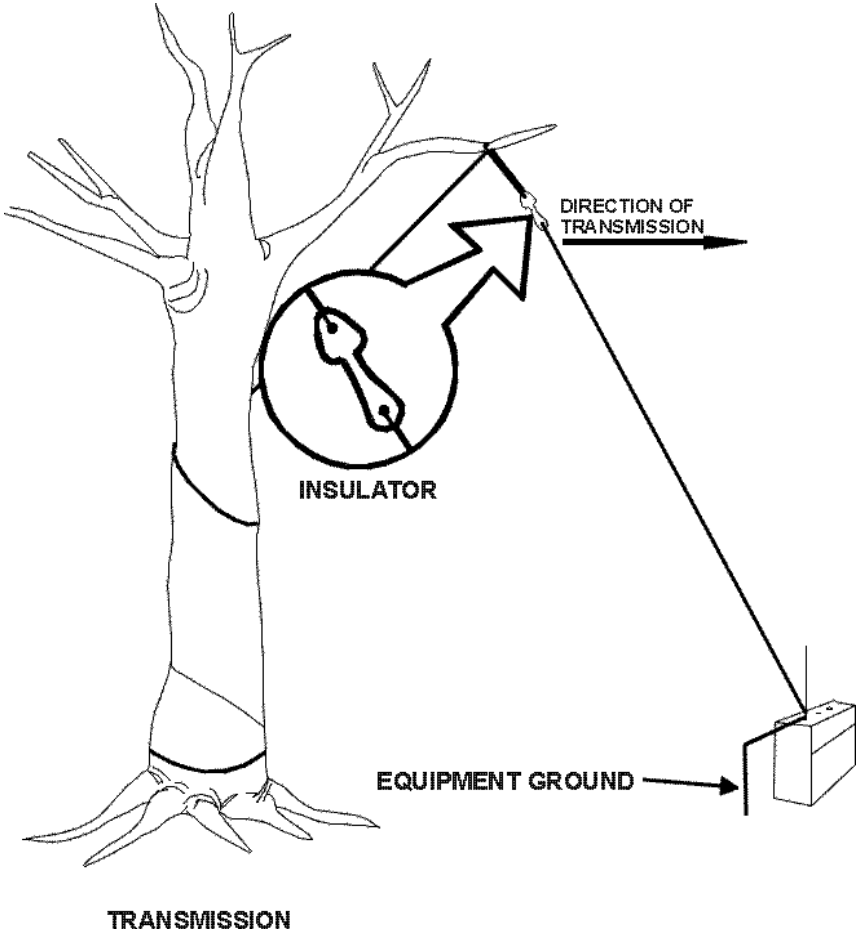

### 5. Verticle Half Rhombic Antenna.

- a. Take four wave lengths of field wire (WD-1/TT) or a multiple of two wave lengths of the operating frequency (use the quick reference antenna length chart on pages D-4 and D-5).

- b. Tie an insulator, knee high, on one end of the wire. Run that end in the direction you wish to talk to. Tie some wire to the other side of the insulator and stake it down with a metal stake. Support the center of the wire with a mast, tree, pole, or whatever is handy (20-30 feet high).

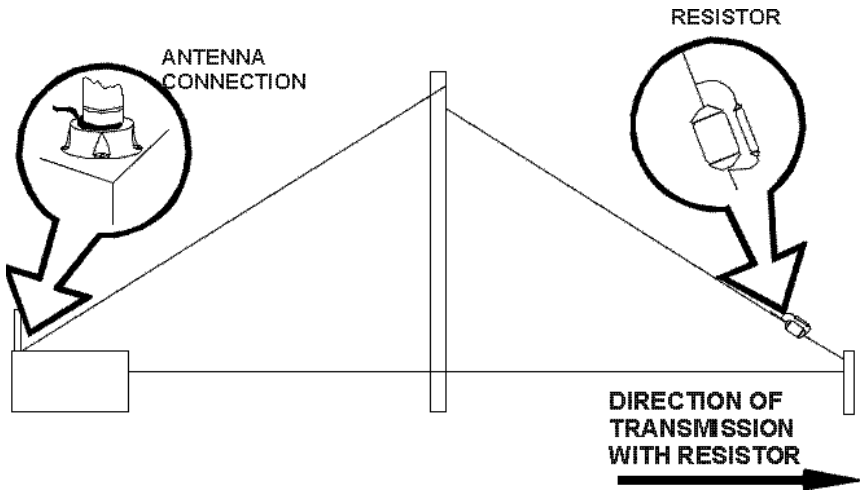

- c. Keep the directional line straight. Extend the near line end until it is tight. Attach the WD-1.
- d. Enhance communications if material and time are available.
- (1) Run a length of WD-1 from the ground stake. Stretch the wire under the antenna about a foot high. Attach the other end of the wire to the handle of the radio set. (This improves the signal. This construction is called counterpoise.)
  - (2) Wire a 600 ohm, 1 or 2 watt carbon resistor across the insulator at the far end; this improves the radio's punch in that direction. (The antenna is bidirectional without the resistor and unidirectional with the resistor.)

## **6. Jungle 292 Antenna.**

This omnidirectional ground plane antenna is a regular RC-292. It is especially good for use in heavily wooded areas.

- a. Compute (or use the quick reference antenna length chart on pages D-4 and D-5) and cut the four wires for a quarter wave. Build a triangle for the bottom of the RC-292. (If possible, find sticks about as long as the elements.)
- b. Connect the WD-1, or coaxial lead-in, as shown in the diagram below, before pulling the antenna up in the air.
- c. Use five insulators, one at each end to separate the elements. Attach an insulator to the vertical element, add a piece of rope, tie on a weight, and throw the rope over a tree limb. (The antenna can then be raised and lowered to change element lengths each time the frequency is changed.)
- d. Add a rope from the bottom of the head of a stake in the ground below if you expect strong winds. (This prevents swaying and a signal that fades in and out.)

*NOTE: Some types of soil absorb radio signals and reduce or eliminate radio signal output from tactical radios. To help overcome this problem, employ a counterpoise or fake ground plane. This keeps the signal from being absorbed into the ground near the radio. To construct a counterpoise for the vertical half rhombic, cut a length of communications wire equal to the distance from the radio to the end of the antenna. Strip the ends of the wire and connect one end to the chassis of the radio (i.e., the battery box latch) and connect the other end to the stake holding the antenna in place. If using a resistor, connect the counterpoise to the end of the resistor that is not connected to the antenna.*

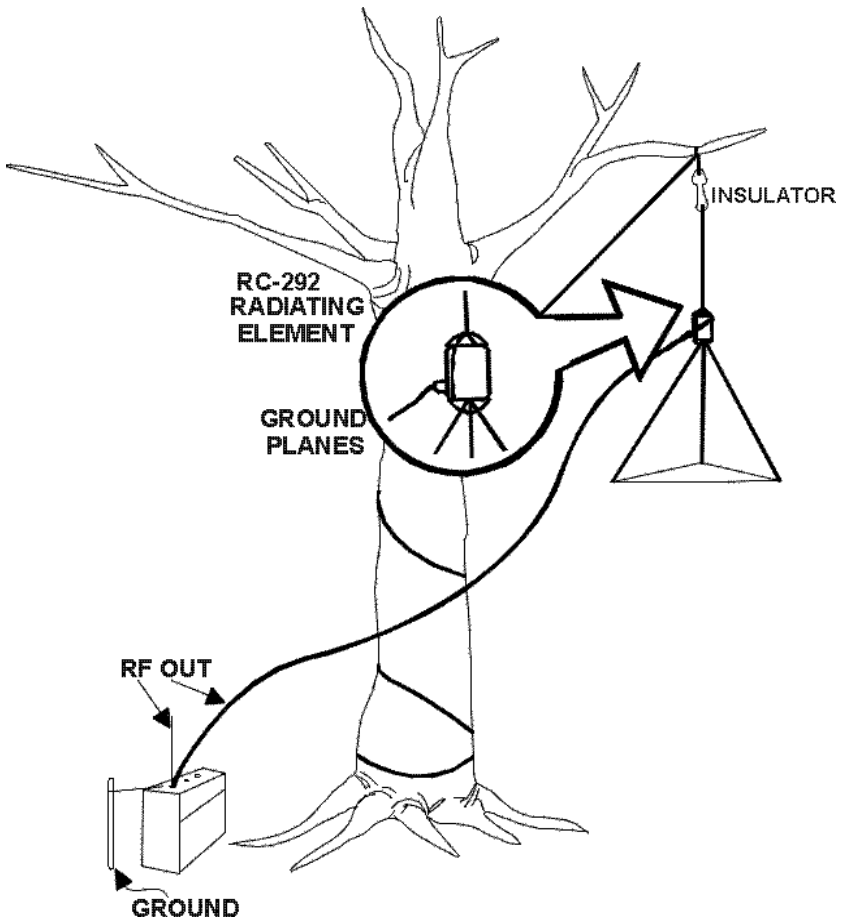

## 7. Commonly Used Infantry Battalion Radio Nets.

Radio Net	Communications Equipment	Units/Individuals on Net
Platoon Tac (VHF)	PRC-68	Platoon commander, squad leaders, attachments
Company Tac (VHF)	PRC-77, PRC-119	Company commander, platoon commanders, company mortars, attachments
Battalion Tac 1 (VHF)	PRC-77, PRC-119, MRC-110	Battalion combat operations center, company commanders, battalion mortars, heavy weapons, attachments
Battalion Tac 2 (VHF)	PRC-77, PRC-119, MRC-110	Battalion combat operations center, company commanders, battalion mortars, heavy weapons, attachments
Battalion Mortars (VHF)	PRC-77, PRC-119, MRC-110	Battalion mortars, battalion combat operations center, mortar forward observers, (81 COF) attachments
Artillery COF (VHF)	PRC-77, PRC-119, MRC-110	Artillery fire direction center, battalion combat operations center, artillery forward observers
TAR/HR (HF)	PRC-104, MRC-138	DASC, battalion combat operations center, forward air controllers
TAD/HD (UHF)	PRC-113, VRC-83	Aircraft, battalion combat operations center, forward air controllers
TACP/Local VHF	PRC-77, PRC-119	Battalion combat operations center, forward air controllers
NGF Ground Spt (HF)	PRC-104, MRC-138	Supporting ships, battalion combat operations center, spot team
SFCP/Local (VHF)	PRC-77, PRC-119	Battalion combat operations center, spot teams

## 8. Communications Security.

### a. General Considerations.

- (1) Communication security is the means or steps that Marines employ to prevent unauthorized persons from gaining military information from Marine Corps communications networks.

- (2) Classification is used to specify the degree of protection required for certain information and is determined by the information's impact on national security.
  - (3) Classified material contains information that has been given a security classification.
  - (4) Communications security applies to documents or written information regardless of its form or characteristics.
- b. Requirements for Handling Classified Information.
- (1) Clearance. An administrative determination of a Marine's eligibility to handle classified materials of a specific classification or category.
  - (2) Need to know. Material a Marine must see in order to perform his/her duties.
  - (3) Access. Authorization to gain possession or knowledge of classified material.
- c. Security Components.
- (1) Emission security measures are taken to deny unauthorized persons information of value that may be derived from intercepts and analysis, thereby compromising transmissions from cryptographic equipment and telecommunications systems.
  - (2) Transmission security measures are designed to protect transmissions from unauthorized interception and exploitation by traffic analysis, imitative deception, and direction finding.
  - (3) Cryptographic security deals with the provisions of technically sound cryptographic systems and the proper

use of authorized codes, cipher devices, and machines employed for encrypting and decrypting messages.

- (4) Physical security is concerned with all physical measures necessary to prevent unauthorized access to equipment, facilities, material, information, and documents and to safeguard them from espionage, sabotage, loss, damage, and theft.

d. **Classifications.**

- (1) Top secret is the most important category and requires the highest degree of protection. If compromised it could cause exceptional damage to national security.
- (2) Secret material requires a substantial degree of protection. If compromised it could cause serious damage to national security.
- (3) Confidential material requires a substantial degree of protection. If compromised it could cause identifiable damage to national security.
- (4) Unclassified material contains no classified information.

**9. SINGARS Radio Information.**

a. **General Considerations.**

- (1) Single-channel ground airborne radio system (SINGARS) integrated communications security (ICOM) radios provide short-range voice and data communications.

- (2) These radios are available in both man-pack and vehicular-mounted configurations
  - (3) Cryptographic equipment has been integrated or built into the radio.
- b. Characteristics.
- (1) Frequency modulated (FM).
  - (2) Frequency range is 30.00 MHz to 87.975 MHz.
  - (3) Channel spacing is 25 kHz.
  - (4) Channels of operation: 2,320.
  - (5) Frequency offset ability is +/- 5 and 10 kHz.
  - (6) Number of preset channels are—
    - ┆ Eight in single-channel mode.
    - ┆ Six in the frequency hopping mode.
  - (7) Emissions include voice, secure voice, and digital data.
  - (8) Power requirement is 13.5 VDC.
  - (9) Radio frequency power output is—
    - ┆ Low (LO): 500 microwatts.
    - ┆ Medium (M): 160 milliwatts.
    - ┆ High (HI): 4 watts.



(10) Rated ranges are—

- | Low (LO): 0 to 330 yards.
- | Medium (M): 330 yards to 2.5 miles.
- | High (HI): 2.5 miles to 5 miles.

(11) Modes of operation are—

- | Single channel (SC).
- | Frequency hopping (FH).
- | Frequency hopping master (FH-M).
- | Retransmission SC to SC, SC to FH, FH to FH, electronic remote fill relay.
- | Remote in either plain or cipher text with AN/GRA-39; control-monitor; or control, receiver-transmitter C-11561(C)/U.

(12) Tuning is electronic. Frequency is entered manually by using the keyboard. Up to eight SC channels and six FH channels can be loaded and later selected using channel switch.

(13) Electronic counter countermeasure capability is the ability to overcome or avoid jamming. SINCGARS is capable of frequency hopping (randomly changing frequencies while maintaining communication). These systems will frequency hop at a rate of up to 6,000 frequencies per minute.

c. Components. See diagram on page D-15.

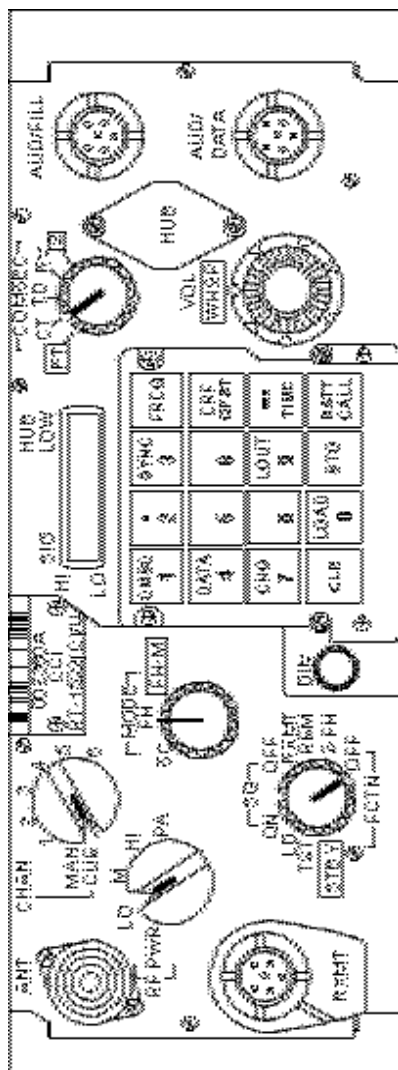

- (1) Receiver transmitter: RT-1523, RT-1523B, or RT-1523C.
- (2) Battery box: CY-8523A.

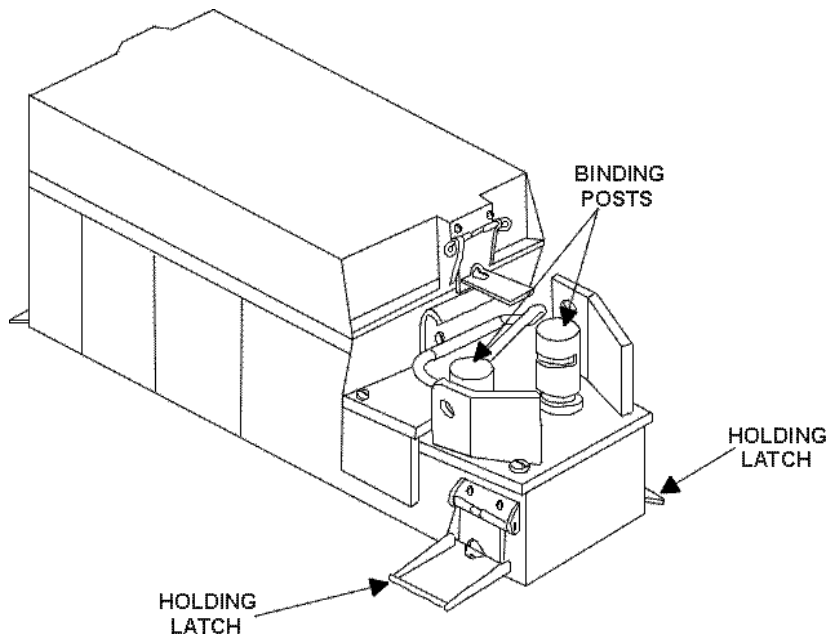

- (3) Antenna: AS-3683A or AS-4266.
  - (4) Handset: H-250.
  - (5) Pack frame: LC-2.
- d. Batteries.
- (1) Power BA-5590 or BB-590 batteries supply the main power source to the radio.
  - (2) Holdup batteries BA-1372 or BA-5372 serve as memory batteries for the radio set.

## Appendix E

# Landing Zone Brief and Markings

### 1. Landing Zone Brief.

1.	MISSION NO.	_____		
2.	LOCATION: COOR/RAD/DME	_____		
3.	UNIT CALL SIGN	_____		
4.	FREQUENCY	PRI UHF _____ SEC UHF _____	FM/VHF _____ FM/VHF _____	
5.	LZ MARKING	_____		
6.	WIND DIRECTION/VELOCITY	_____ / _____		
7.	ELEVATION/SIZE/SHAPE	_____ / _____ / _____		
8.	OBSTACLES	_____		
9.	FRIENDLY POSITIONS: DIRECTION/DISTANCE	_____ / _____		
10.	ENEMY POSITIONS: DIRECTION/DISTANCE	_____ / _____		
11.	LAST FIRE RECEIVED: TIME/TYPE	_____ / _____		
12.	DIRECTION OF FIRE/DISTANCE	_____ / _____		
13.	CLEARANCE TO FIRE: DIRECTION/DISTANCE	_____ / _____		
14.	APPROACH/RETIREMENT (RECOMMENDED)	_____ / _____		
15.	PERSONNEL/EQUIPMENT	_____ / _____		
16.	OTHER	_____		
	a. FORMATION	_____		
	b. _____	_____		_____

## 2. Landing Zone Markings.

- a. Landing zone lighting diagram of a NATO inverted "Y" prior to landing.

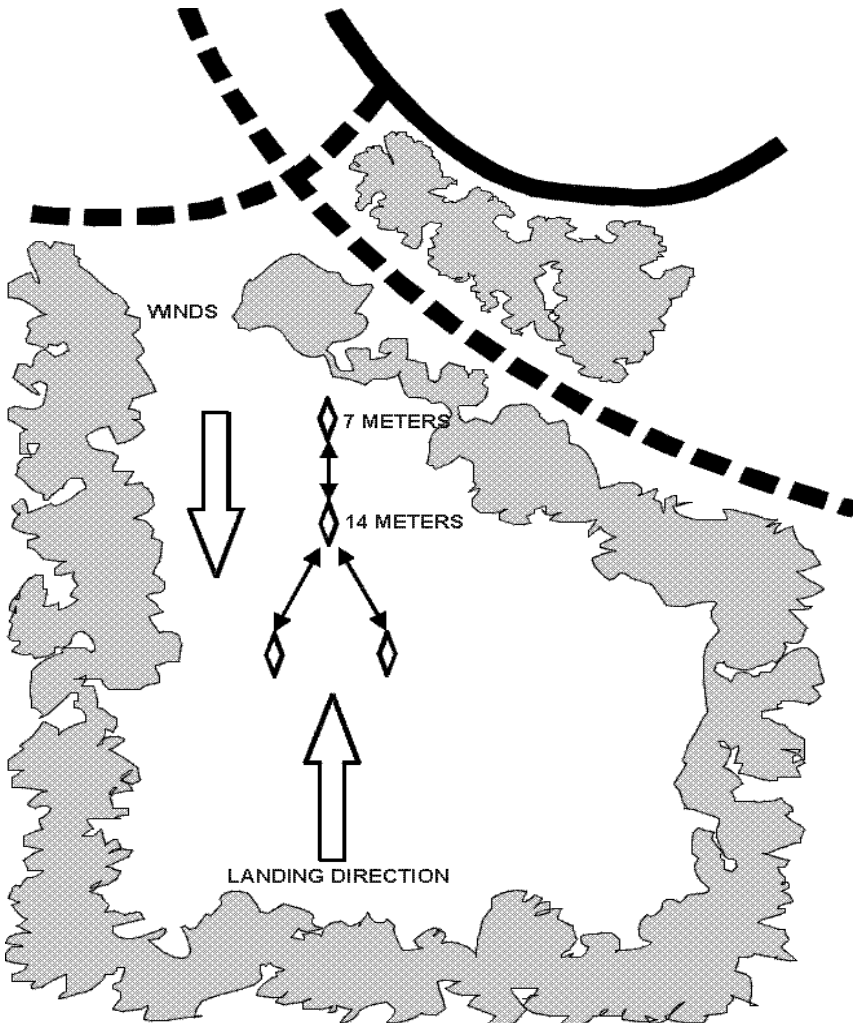

- b. Landing zone lighting diagram of a NATO inverted “Y” after landing.

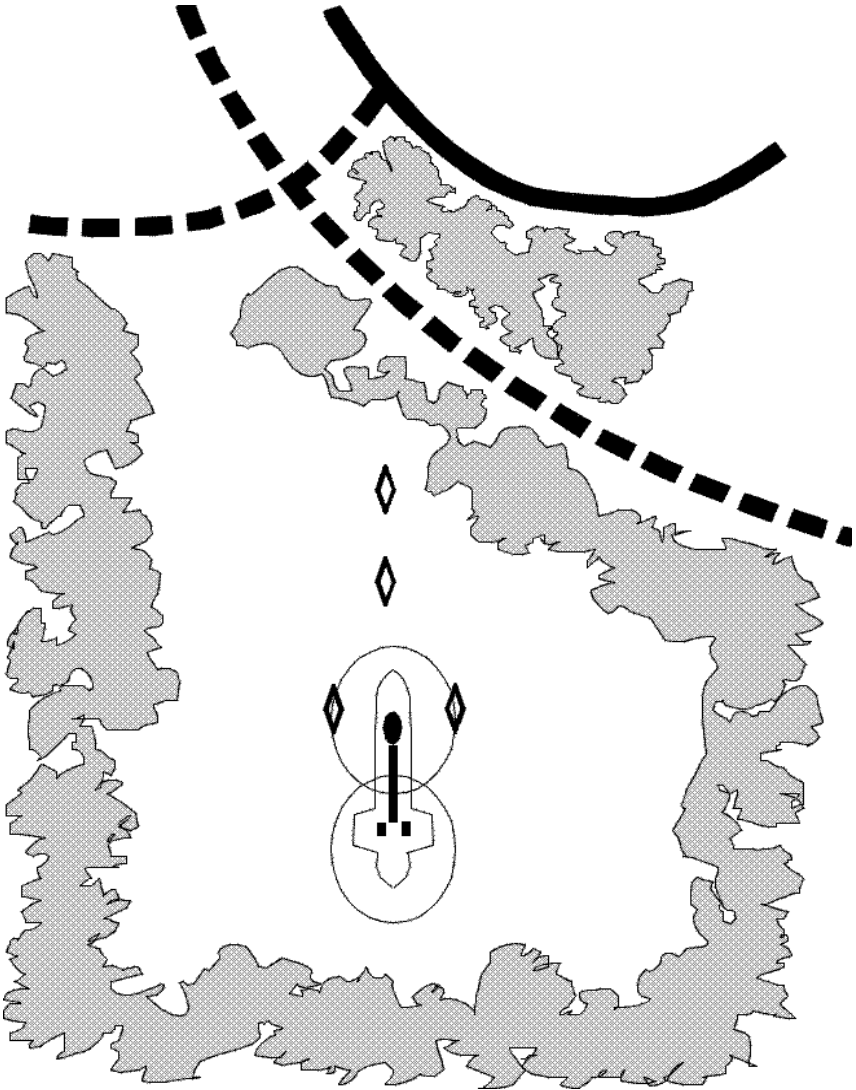

## Appendix F

### Sample Fire Plan Sketches

#### 1. Squad Fire Plan Sketch.

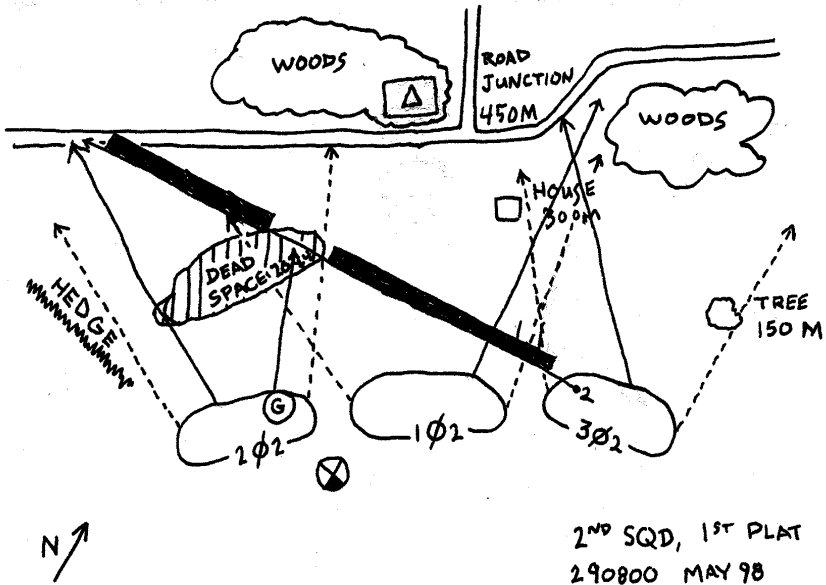

## 2. Platoon Fire Plan Sketch.

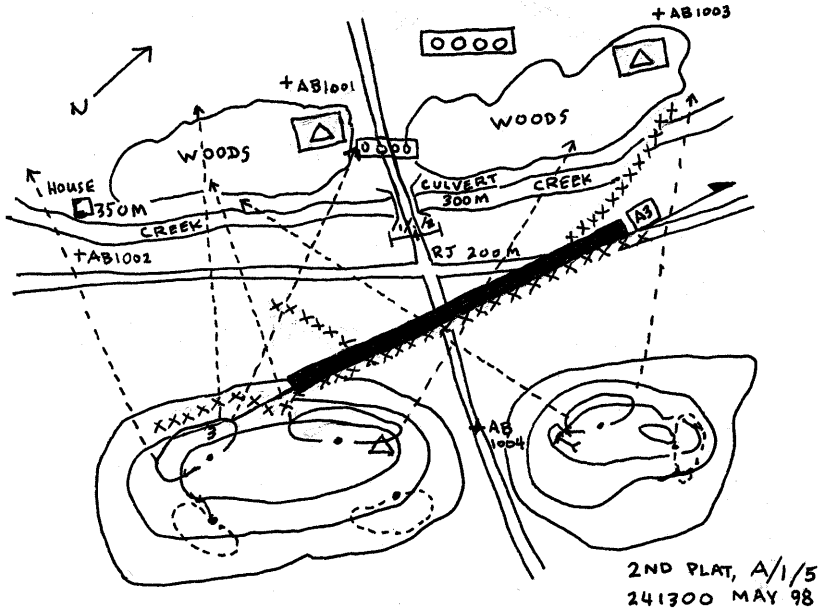



### 3. Company Fire Plan Sketch.

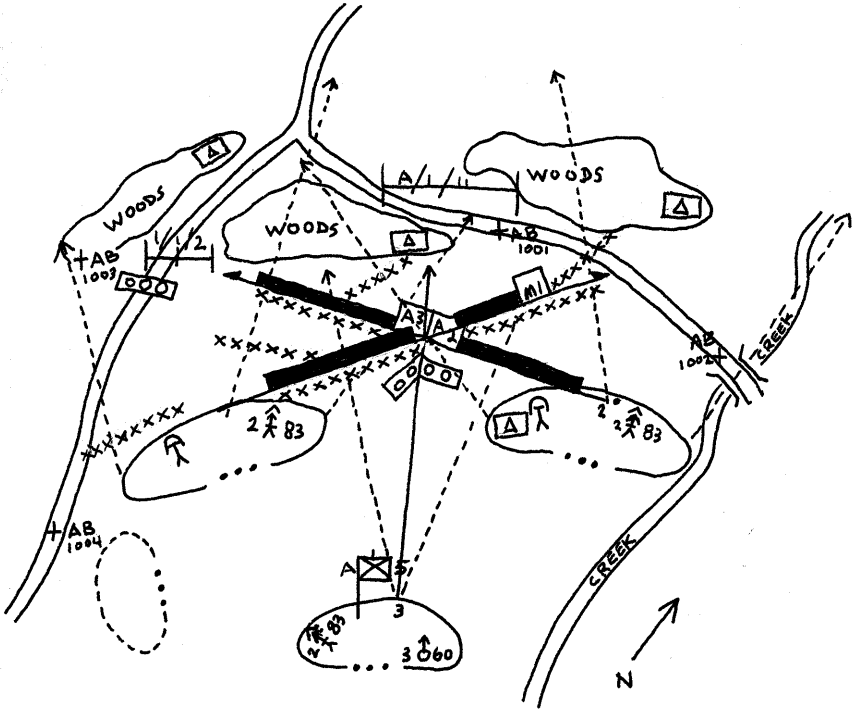

A/1/5  
GRID CO CP 801329  
241500 MAY 98

## Appendix G

### Roadblocks and Searches

#### 1. Types of Roadblocks.

- a. **Planned.** A planned roadblock is a permanent or semi-permanent roadblock used on borders, outskirts of cities, or on the edge of controlled areas. They are valuable for checking identifications and as a deterrent. See page G-2 for an example of a planned roadblock.
- b. **Hasty.** A hasty roadblock is a temporary roadblock used for spot checks. Its main value is the element of surprise and it is most effective within the first half an hour of being in position—before word on its presence spreads through the local population. It can consist of two vehicles placed diagonally across a road, or a coil of barbed wire, or just traffic cones. See page G-3 for an example of a hasty roadblock.

**EQUIPMENT**

- STOP SIGNS
- BARRIERS
- CALTROPS (TIRE PUNCTURING)
- RADIOS
- WIRE
- LIGHTS
- SURVEILLANCE EQUIPMENT
- TENTS
- HANDCUFFS/FLEXCUFFS
- METAL/EXPLOSIVES DETECTORS
- LIST OF WANTED CARS/MEN
- MEGAPHONE/LOUDSPEAKER
- WHISTLES

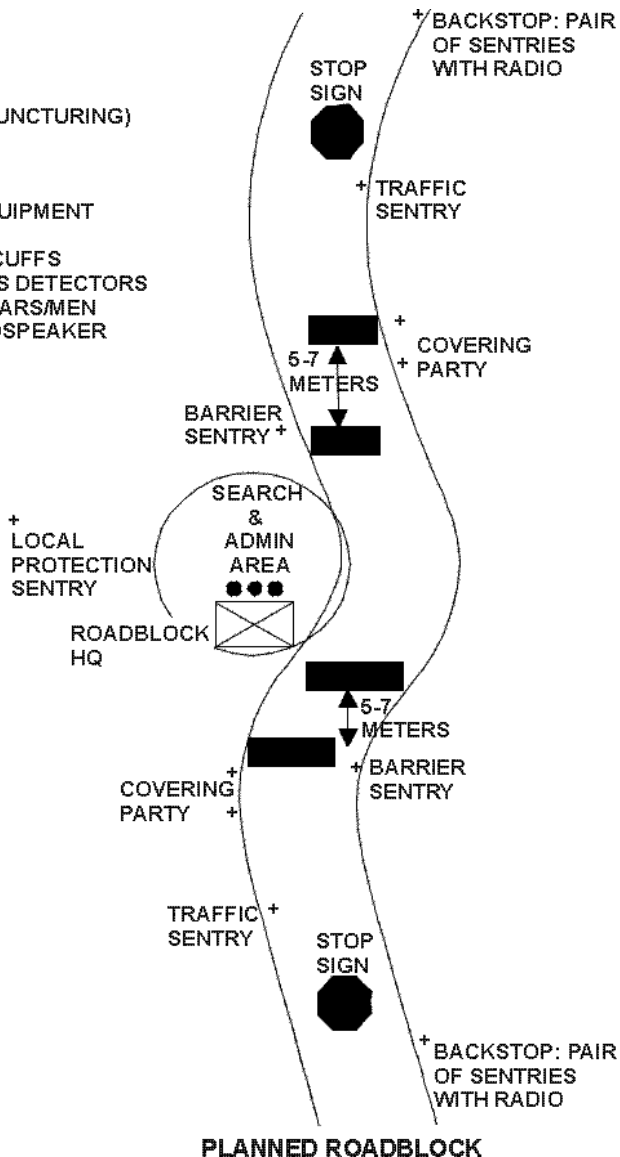

**PLANNED ROADBLOCK**

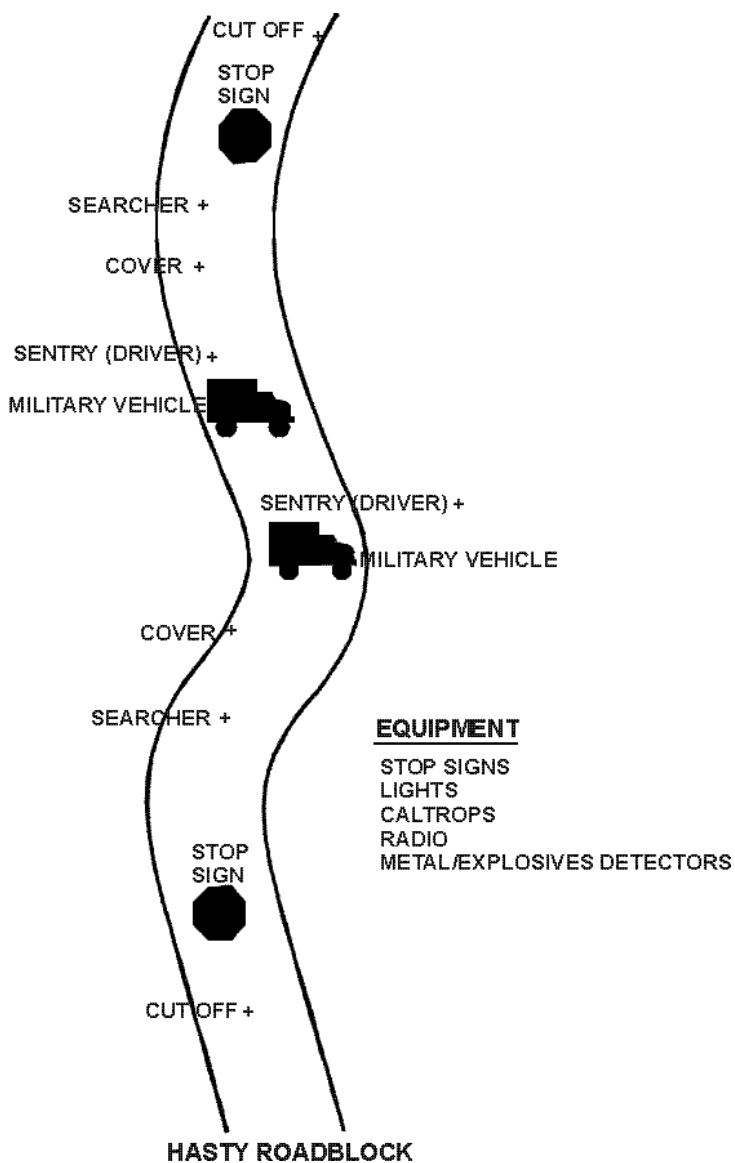

## **2. Planning Considerations.**

- a. To avoid unnecessarily annoying innocent civilians, personnel manning roadblocks should—
  - 1 Know and understand the rules of engagement.
  - 1 Know their jobs thoroughly and act quickly and methodically.
  - 1 Be polite and considerate at all times.
  - 1 Hand over suspects to civil police quickly and with minimum disturbance.
- b. The following considerations may apply when planning and executing roadblocks:
  - (1) Concealment. Tactically site the roadblock where it cannot be seen more than a short distance away. (Sharp bends or dips in the road are ideal.)
  - (2) Security. Plan for enough troops to protect the roadblock. Plan for enough sentries and cover groups. Stop vehicles well short of the main search area to minimize the effect of vehicle bombs.
  - (3) Construction and layout. See sample layout of planned and hasty roadblocks on page G-2 and page G-3, respectively.
  - (4) Manning. Determine the number of troops based on the threat and the expected column of traffic. Additional personnel (i.e., civil police, female searchers, interpreters, and explosive ordnance experts) may be necessary.

- (5) Surveillance. Consider the value of using early warning and night observation devices.
- (6) Communications. Establish essential external and internal communications.
- (7) Rule of engagement. Ensure Marines manning roadblocks are aware of their legal powers and duties with regard to search, arrest, and use of force.

### **3. Personal Searches.**

- a. The person being searched should be made to stand with legs apart in a leaning position, placing hand against a wall or vehicles. This position would prohibit movement without falling down but would allow them to be knocked over easily.
- b. The searcher should always work from behind the individual being searched.
- c. Two searchers should be employed, one to conduct the search and the other to cover.

### **4. Type of Searches.**

- a. A quick body search or frisk is used as a preliminary search to detect weapons that might be used against the searcher or as the usual form of search in a low threat area. (One out of 10 people may be selected for a more thorough search.)
- b. A detailed body search is used as a more meticulous, detailed search of the entire person to check for weapons or contraband. The search should follow a logical sequence from top to toe, as is often done at airports. Clothing should not be patted; use a stroking movement instead. Both hands should

be used for the search. The following areas should be carefully checked:

- | The hair (in or under hats).
- | Armpits.
- | Inside legs.
- | Half-clenched hands.
- | Any medical dressings.
- | Any carried bags or cases.
- | Walking sticks, umbrellas, and crutches.
- | Shoes/boots.

## **5. Vehicle Searches.**

Refer to the Vehicle Search Card when conducting searches.

- a. Occupants. Remove occupants from vehicles and search drivers and passengers. Also, search any loose baggage in the passenger area.
- b. Car trunk. Direct the driver to open and identify contents. Search—
  - | Under and around the spare tire.
  - | Tool boxes.
  - | Luggage.
  - | Partition between trunk and rear seat.
  - | Spare tire housing if it is under the vehicle.
  - | Spare tire (use tool kits to test the air in the spare tire).





- c. Car hood. Direct the driver to open the hood and check—
  - | Items taped to bulkhead or hood.
  - | All containers.
  - | Oil and air filters.
  - | Behind sound proofing.
  - | Front grill.
  - | Heater.
  
- d. Car interior. Be suspicious of strong smelling perfume. Check methodically from front to rear. Search—
  - | Behind the dash.
  - | Fittings such as radio/cassette player.
  - | The glove compartment.
  - | Behind panels; check screws.
  - | Under the floor mats.
  - | In, under, and behind seats and cushions.
  - | Window tracks by rolling them down.
  - | Toys and decorative animals.
  - | Ashtrays.
  
- e. Car exterior. Search—
  - | Wheel wells.
  - | Behind bumpers.
  - | Headlights.
  - | Hubcaps.
  - | Underside.

- f. Commercial vehicles. In addition to the searches listed in steps a. through e., the following searches should also be performed on commercial vehicles:
- | Drivers's cab.
  - | Space between body and cab.
  - | External stowage area/bins.
  - | Wooden bodies, false doors, and sides.
  - | Space between rear double wheels.
  - | Wheel chocks that can be hollowed out.

Remember to—

- | Include vehicle search information in the brief for setting up roadblocks and conducting personnel searches.
- | Always have someone covering the searchers and those being searched.
- | Make the vehicle occupant(s) open all doors and compartments.
- | Use explosive detectors or dogs in searches, if possible.

## Appendix H

# Enemy Prisoners of War

### 1. General.

- a. Enemy prisoners of war EPW(s) are a good source of information.
- b. EPWs must be handled per international law and without losing a chance to gain intelligence.

### 2. Handling EPWs.

- a. Search EPWs as soon as they are captured.
  - (1) Take their weapons and papers, except identification papers.
  - (2) Give them a written receipt for any personal property and documents taken.
  - (3) Tag EPWs' documents and personal property.
  - (4) Have one man guard while another searches.
  - (5) Re-search any EPWs that are relocated.
- b. Segregate EPWs into groups: officers, noncommissioned officers, enlisted men, civilians, males, females, and political figures. Segregation helps prevent EPW leaders from organizing, giving support, and promoting escape efforts. Keep groups segregated as they move to the rear.

- c. Silence EPWs.
  - (1) Prohibit EPWs from talking to each other. This also keeps them from planning an escape, from cautioning each other on security, and from inventing or coordinating stories that could result in lost intelligence opportunities.
  - (2) Report anything an EPW says to you or tries to say to another EPW to the S-2.
- d. Speed EPWs to the rear. Platoons turn EPWs over to the company. Use guards to move EPWs to the rear for questioning by the S-2.
- e. Safeguard EPWs when moving them to the rear.
  - (1) Make sure they arrive safely.
  - (2) Watch out for escape attempts.
  - (3) Ensure that they do not bunch up, spread too far out, or start diversions (e.g., fist fights). These create a chance for escape.
  - (4) Ensure that no one abuses them.
- f. Tag EPWs and their possessions using an Enemy Prisoner of War (EPW) Capture Tag (DA Form 5976). See sample form on pages H-4 and H-5.
  - (1) Tag the EPW before evacuation to the EPW collection point.

- (2) Tag any enemy documents and equipment. If an item was found on an EPW, his name should be on the tag, and the item should be separated from him. (See Part C of DA Form 5967.)
- (3) Evacuate all documents found on an EPW with the EPW.

1 DATE AND TIME OF CAPTURE		2 SERIAL NO <b>XXXXXX1A</b>	
3 NAME			4 DATE OF BIRTH
5 RANK		6 SERVICE NO	
7 UNIT OF EPW		8 CAPTURING UNIT	
9 LOCATION OF CAPTURE ( <i>Grid coordinates</i> )			
10 CIRCUMSTANCES OF CAPTURE		11 PHYSICAL CONDITION OF EPW	12 WEAPONS, EQUIPMENT, DOCUMENTS
-----			
1 DATE AND TIME OF CAPTURE		2 SERIAL NO <b>XXXXXX1B</b>	
3 NAME			4 DATE OF BIRTH
5 RANK		6 SERVICE NO	
7 UNIT OF EPW		8 CAPTURING UNIT	
9 LOCATION OF CAPTURE ( <i>Grid coordinates</i> )			
10 CIRCUMSTANCES OF CAPTURE		11 PHYSICAL CONDITION OF EPW	12 WEAPONS, EQUIPMENT, DOCUMENTS
-----			
1 DATE AND TIME OF CAPTURE		2 SERIAL NO <b>XXXXXX1C</b>	
3 NAME			4 DATE OF BIRTH
5 RANK		6 SERVICE NO	
7 UNIT OF EPW		8 CAPTURING UNIT	
9 LOCATION OF CAPTURE ( <i>Grid coordinates</i> )			
10 DESCRIPTION OF WEAPONS, SPECIAL EQUIPMENT, DOCUMENTS			

**FRONT**

**Enemy Prisoner of War Capture Tag**

**ENEMY PRISONER OF WAR (EPW) CAPTURE TAG (Part A)**

For use of this form, see AR 190-8, the proponent agency is DCSOPS

**Attach this part of tag to EPW. (Do not remove from EPW)**

- 1 **Search** – For weapons, military documents, or special equipment
- 2 **Silence** – Prohibit talking among EPWs for ease of control
- 3 **Segregate** – By rank, sex, and nationality
- 4 **Safeguard** – To prevent harm or escape
- 5 **Speed** – Evacuate from the combat zone
- 6 **Tag** – Prisoners and documents or special equipment

DA Form 5976, JAN 91

---

**UNIT RECORD CARD (Part B)**  
**Forward to Unit**  
**(Capturing unit retains for records.)**

Use string, wire, or other durable material to attach the appropriate section of this form to the EPW's equipment or property

DA Form 5976, JAN 91

---

**DOCUMENT/SPECIAL EQUIPMENT/WEAPONS CARD (Part C)**

**Attach this part of tag to EPW's retained property. (Do not remove from property.)**

As a minimum, the tag must include the following information:

- *Item 1*, date and time of capture.
- *Item 8*, capturing unit.
- *Item 9*, place of capture (*grid coordinates*).
- *Item 10*, circumstances of capture (*how the EPW was captured*).

DA Form 5976, JAN 91

**BACK**

### 3. Types of Searches.

- a. A hasty search is a good pat down of the EPW's entire body, checking all pockets and areas where the EPW could conceal weapons or documents. Done only when time is paramount.
- b. A detailed search is similar to a hasty search, but in more detail. Search EPWs thoroughly, checking for hidden pockets on the inside of the uniform, belts, and boots.
- c. A strip search is the most preferred search. Strip EPWs of all clothing to ensure there are no hidden weapons, booby traps, or documents. Check all clothing for hidden compartments. Remember to return the EPW's protective gear.

*Note: For female EPWs, care must be taken to ensure compliance with international law. Females search females. If none are available, the order of precedence for searchers is medical personnel, members of the clergy, and if none of the aforementioned are available, the senior officer on site.*

### 4. Procedures for Handling and Searching EPWs.

- a. Search EPWs located within an enclosed space first during a hasty search.
- b. Cover all EPWs (continue to cover immediate danger areas).
- c. Sweep visible weapons away from all the occupants in an enclosure.
- d. Check suspected dead.
- e. Flex cuff all EPWs.
- f. Conduct hasty search of the dead for weapons.
- g. Conduct hasty search of the living prisoners.



- h. Escort living prisoners to the marshaling area where they will be detail searched and staged.
- i. Detail search the dead and leave in place.
- j. Mark dead once they have been searched.

## Appendix I

### Patrol Coordination

#### 1. Patrol Leader.

The patrol leader ensures that the listed issues are addressed when coordinating with the following:

##### S-2.

- | Current enemy situation.
- | Terrain and vegetation.
- | Weather and light data.
- | Previous patrol reports.
- | Aerial photos and imagery.
- | Photos or information on enemy uniforms and weapons.
- | Priority intelligence requirements and information requirements (information to be collected).
- | Debrief (who, where, when).
- | Special equipment.
- | Sniper attachments.

##### S-3.

- | Submission of route overlay.
- | Current friendly situation.
- | Departure/reentry of friendly lines—

- o Time and place (coordinated with the forward unit commander).
- o Emergency signals.
- | Adjacent patrols.
- | Restrictions (illumination, smoke, riot control agents, pyrotechnic).
- | Required reports and reporting occasions.
- | Location and time of rehearsal.
- | Location and time of test firing of weapons.

**Fire support coordinator.**

- | Fire support means available.
- | Ammunition types and fuzes available.
- | Priority of fires.
- | Priority targets.
- | Control measures (coordinated fire line and boundaries).
- | Frequencies and call signs.
- | Submission of fire support overlay.

**S-4 (or company gunnery sergeant).**

- | Equipment requests.
- | Time and location to draw.
- | Ammunition and pyrotechnic requests.
- | Transportation.

Air officer.

- | Aircraft availability.
- | Frequencies and call signs.

Communications officer.

- | Frequency, call signs, and times when they change.
- | Reporting instructions.

Weapons platoon commander.

- | Attachments.
- | Debrief.
- | Fire support assets (60mm mortars).

Adjacent patrols.

- | Identity of patrol leader.
- | Identity of unit.
- | Size of patrol.
- | Time of departure/time of return.
- | Enemy action.
- | Routes (primary/alternate).
- | Mission.
- | Frequencies and call signs.
- | Challenge and password.

## **2. Coordination with Forward Unit Commander.**

The patrol leader ensures that the following items are coordinated with forward unit commanders in areas where the patrol may operate or pass.

### Information provided.

- | Identity of the patrol leader.
- | Identity of the unit.
- | Size of patrol (at time of departure and time of return).
- | Mission of patrol.
- | Time of departure and time of return.
- | General area of operation.
- | Patrol frequencies and call signs.

### Information collected.

- | Terrain and vegetation.
- | Enemy situation.
- | Friendly positions.
- | Barrier plan.
- | Fire support plan.
- | Units' frequencies and call signs.
- | Challenge and password.

Information coordinated.

- | Location of initial rally point and return rally point.
- | Location of point of departure and point of return from friendly lines.
- | Departure/reentry procedures.
- | Frequencies and call signs.
- | Emergency signals/plans.
- | Passage of information to relief.

Support requested.

- | Guide through lines.
- | Fire support.
- | Reaction force.
- | Litter team.
- | Navigational aids.

# Appendix J

## Example Patrol Overlay

**Patrol leader:** Sgt Smith  
**Unit:** 1st Sqd, 2nd Plt, I 3/2  
**Date of patrol:** 7 May 1984

**Map sheet:** New River  
**Scale:** 1:50,000  
**TOD:** 1845  
**TOR:** NLT 0230

**Patrol frequencies:**  
 Primary: 33.60  
 Alternate: 45.70  
 Call sign: N4A  
 Emergency signal: \_\_\_\_\_

**Code words:**  
 Switching to alternate frequency: Eagle  
 Switching to alternate route: Blue

**Primary route**  
 POD: 754 283  
 CP5: 757 287  
 CP4: 758 291  
 FPP/OPR: 760 295  
 OBJ: 760 296  
 CP9: 753 293  
 CP2: 754 288  
 POR: 752 282

**Alternate route**  
 POD: 754 283  
 FPP/OPR: 760 295  
 CP7: 756 292  
 CP6: 751 287  
 POR: 752 282

Primary route →  
 Alternate route - - - →

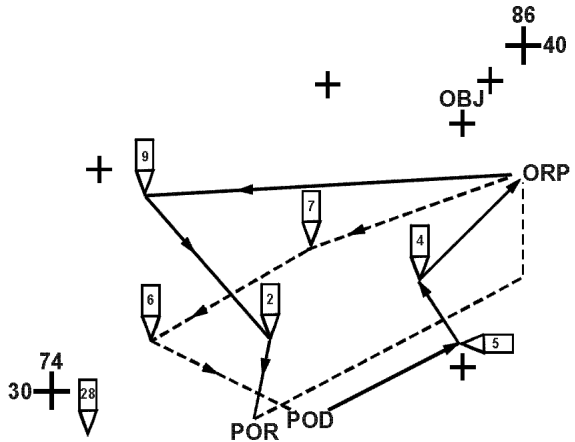

### Target List

Checkpoint	Number	Location	Description	Remarks
	AB1001	756 290	Road junction	HE/WP
	AB1002	760 297	Road (objective)	
	AB1003	763 297	Road junction	VT
	AB1004	758 297	Road junction	VT
	AB1005	752 293	Hill top	HE/WP





## Appendix K

# Close Air Support Aircraft Capabilities and Munitions

## Aircraft Capabilities

<b>Aircraft</b>	<b>Ordnance Types</b>	<b>Maximum Load</b>	<b>Gun Type</b>	<b>Time on Station</b>
AV-8B	All conventional unguided, Maverick	8,000 lbs	25mm, 399 rounds	30 min
F/A-18	All conventional unguided, Maverick, Walleye	13,500 lbs	20mm, 580 rounds	35 min
AH-1W	Rockets, TOW, Hellfire	2,000 lbs	20mm, 750 rounds	1 hr +30 min
A-10	All conventional unguided, Maverick	5,100 lbs	30mm, 1174 rounds	
F-14	General purpose (MK 80s) and cluster munitions	8,000 lbs	20mm, 515 rounds	
F-15	All conventional unguided, Maverick, Walleye	6,000 lbs	20mm, 512 rounds	
F-16	All conventional unguided, Maverick, Walleye	6,000 lbs	20mm, 515 rounds	

1. CAS times on station (TOS) reflect 30 minute transit to/from target area.

## Conventional Unguided Munitions

<b>Munition</b>	<b>Description</b>	<b>Suitable Targets</b>
MK 82	500 lb bomb	Bunkers, vehicles, troops, artillery position
MK 83	1,000 lb bomb	Bunkers, vehicles, troops, artillery position
MK 84	2,000 lb bomb	Bunkers, vehicles, troops, artillery position
MK 20 Rockeye	DPICM w/ 247 bomblets	Troops, tanks, POL site, artillery position
CBU 59 APAM	DPICM w/ 717 bomblets	Troops, med tanks, POL site, artillery position
CBU 72 FAE	Fuel air explosive	Troops, POL site, bldgs, artillery position
MK 77 napalm	Firebomb	Troops, POL site, vehicles
Rockets 2.75"/5.00"	Pod-launched area fire weapon	Troops, vehicles, POL site

## Conventional Guided Munitions

<b>Munitions</b>	<b>Description</b>	<b>Suitable Targets</b>
AGM-65 Maverick	Infrared or laser-guided missile	Any point target (SAM site, APC)
Walleye	Optically-tracked 2,000 lb. bomb	Reinforced bunkers, ships
BGM 71 TOW	Wire-guided antiarmor missile	Armor, APCs any point target
AGM 114 Hellfire	Laser-guided antiarmor missile	Any tank, any point target

1. All MK 80 series general-purpose bombs may be fitted with a—
  - 1. High-drag fin or drogue shoot assembly allowing for low-level (below 2,000 feet) delivery.
  - 1. Laser-guided bomb kit allowing for point target capability with a single bomb.
2. All laser-guided weapons require target designation for employment.

## Appendix L

### Weapons Capabilities

Weapons	Maximum Effective Range (meters)	Ammunition	Rates of Fire Rounds Per Minute		Effective Casualty Radius	Remarks
			Rapid	Sustained		
Hand grenades fragmentation M67	40	HE	N/A	N/A	15m	4-5 second fuze delay
White phosphorus M34	30	WP	N/A	N/A	35m	4-5 second fuze delay
Riot control M7A2	40	CS	N/A	N/A	25m	2 second fuze delay; functions for 20 to 60 seconds
Riot control M25A2	50	CS	N/A	N/A	5m	1.3-4 second fuze delay
Incendiary AN-M14	N/A	Thermite	N/A	N/A	Will burn through 1/2 in. of steel	2 second fuze delay; burns for 40 seconds at 4,000° F
Illumination MK1	40	Illumination	N/A	N/A	Illuminates 200m	7 second fuze delay
Smoke colored M18	35	Yellow, red, green	N/A	N/A	N/A	2 second fuze delay
Pistol 9mm	50	Ball	N/A	N/A	N/A	
Rifle 5.56 M16A2	550	Ball, tracer		12-15	N/A	May be fired semiautomatic or 3 round burst.
Grenade launcher 40mm M203	150 point target 350 area target	HE, WC, WSP, HEDP, CS multiprojectile, HE bounding	Maximum effective 7-9 rounds per minute		5m	M203 is mounted under the M16AZ
Squad automatic weapon 5.56 M249	1,000	Ball and tracer 4+1 link	200	85	N/A	Fire from a linked belt or M16 magazine grazing fire 600m 3-5 round burst
Machine gun 7.62 M60E3	1,000	Ball and tracer 4+1 link	200	100	N/A	Grazing fire 600m 6-8 round burst
Machine gun 7.62 M240G	1,800	Ball and tracer 4+1 link	200	100	N/A	Grazing fire 600m 6-8 round burst
Machine gun .50 HB M2	1,830	HEDP	40+	40 rounds or fewer	2 inches of steel at 90 degrees	Grazing fire 1000m designed to be fired in 3-5 round bursts

Weapons	Maximum Effective Range (meters)	Ammunition	Rates of Fire Rounds Per Minute		Effective Casualty Radius	Remarks
			Rapid	Sustained		
MK-19 40mm	1,500	HEDP TP	60	40	15m 2 in. steel	Maximum range 2,212m Minimum safe range combat-75m training-310m
Assault rocket launcher 83mm ARL SMAW	400 area 250 point HEDP 500 HEAA	HEDP HEAA, practice, 9mm tracer	N/A	N/A	7 1/2 ft. reinforced sandbags 8 in. concrete 12 in. brick 1 in. armor	9mm spotting rifle and rocket launcher are bal- listically matched.
Mortar 60mm M224	M720 HE 3,500 M772 WP 3,500 M721 ILLUM 3,200	HE, WP, ILLUM	30 rounds per minute	20	HE - 27.5m WP 10m ILLUM- 500m radius 40 sec- onds	FPF for section 30 x 90
Mortar 81mm M252	M889 HE 5,700 M375 WP 4,500 M853A1 ILLUM 5,100	HE, WP, RP, ILLUM IR ILLUM	30 rounds per minute/ 2 minutes	15	HE-35 WP-15 ILLUM-500m 60 seconds IR ILLUM 74 seconds	M532 proximity fuze is available. The fuze will function 3-30 ft. above ground FPF for section 140 x 35 FPF for platoon 280 x 35
Howitzer 155mm M198 (towed)	14,700 chg 7 18,100 chg 7 Red 30,000 RAP	HE, ILLUM, WP, SMK, ICM, ADAM, RAAM, HD, GB, VX, CLGP Fuzes: Q,D,Ti,VT,CP	4	2	50m	FPF for battery 300 x 50
57/54	21,887	HC, ILLUM, HE, WP Fuzes: PD, MT, VT, CVT, Delay	20	16	45m	
AT-4	300	HEAT	N/A	N/A	In excess of 17 in. of steel	Minimum range is 10m
Dragon M47	1,000	HEAT	N/A	N/A	24 in. of steel	Minimum range is 65m
TOW M220	3,750	HEAT	N/A	N/A	In excess of 25 in. of steel	Minimum range is 65m

Weapons	Maximum Effective Range (meters)	Ammunition	Rates of Fire Rounds Per Minute		Effective Casualty Radius	Remarks
			Rapid	Sustained		
LAV 25mm	2,000	HE-I, APDS target practice	200	100	Will penetrate a BMP at 2,200m	
Tank 120mm	2,200	HEAT, HEP, APDS, WP, APERS	Crew dependent		HEAT/APDS is effective against all types of armor at 2,200m	

## Appendix M

### Common Threat Weapon Characteristics

Weapon	Range	Guidance	Remarks
<b>Antiaircraft Weapons</b>			
ZSU-23-4	2,500m 3,000m	Optical track Radar track	Cyclic rate of fire 4,000 rounds per minute
SA-6	24 km	Radar	Tracked vehicle
SA-7	3.5 km	IR heat seeker	Man portable
SA-8	10 km	Radar	Wheeled vehicle
SA-9	8 km	IR heat seeker	BRDM vehicle
SA-14	4.5 km	IR heat seeker	Man portable
SA-16	5.2 km	IR heat seeker	Man portable
S-60 57mm Antiair	6 km	Radar tracked towed	4.2 km optical track
<b>Small Arms</b>			
AK-47, 7.62mm	400m		Asia, Middle East, China, Finland, North Korea
AK-74, 7.62mm	400m		
RPK-74, Light MG, 5.45mm	800m		
FN, 7.62mm FAL Rifle	650m		
65, 7.62mm H&K Rifle	800m		
RPD, 7.62mm light MG	800m		China, Vietnam, North Korea, Egypt, Pakistan
RPK-74, 5.45mm	800m		
SVD, 7.62mm Sniper Rifle	900m		

<b>Weapon</b>	<b>Range</b>	<b>Guidance</b>	<b>Remarks</b>
<b>Crew-Served Weapons</b>			
AGS-17, 30mm Auto Grenade Launcher	1,730m		
SG43/SGM Goryunov, 7.62mm Medium MG	1,000m		Middle East, Africa, Asia
KYPT, 14.5mm, HMG	2,000m		
NSV, 12.7mm HMG	2,000m		
KPV, 14.5mm MG	2,000m	Mounted on BTR-60/ 70/80, BRDM-2	
M37, 82mm Mortar	3,000m		
M43, 120mm Mortar	5,700m		
<b>Rocket-Propelled Grenade (RPG)</b>			
RPG-7, Rocket	300- 500m		
RPG-16, Rocket	500- 800m		
RPG-18, Rocket	200m		
RPG-22, Rocket	250m		
<b>Antitank-Guided Missiles (ATGM)</b>			
Malyutka (AT-3)	3,000m		
Fagot (AT-4)	2,500m		
Konkurs (AT-5)	4,000m		
Shturm (AT-6)	5,000m		
Metis (AT-7)	1,000m		
Kobra (AT-8)	4,000m		
Ataka (AT-9)	6,000m		
Basnya (AT-10)	4,000m		
Svir (AT-11)	5,000m		
Metis (AT-13)	1,500m		

<b>Weapon</b>	<b>Range</b>	<b>Guidance</b>	<b>Remarks</b>
<b>Armored Vehicle Weapons</b>			
ZSU 23, 23mm Cannon	2,500m		
125mm, Main Gun T-64, T-72, T-80	2,000– 2,500m		
30mm Cannon BMP	1,800– 2,000m		
<b>Artillery</b>			
D-30 122m Howitzer	15,400m		
152mm SP Gun, 2S5	28-33km		



## Appendix N

### Antiterrorism Procedures

#### 1. Personal Protective Measures.

- a. Obey security orders.
- b. Know your interior guard routines.
- c. Be inquisitive.
- d. Remain aware of your surroundings.
- e. Keep alert.

#### 2. Personal Routines.

- a. Avoid wearing uniform if possible.
- b. Avoid calling each other by rank while in civilian areas.
- c. Vary patronage of eating/socializing establishments.
- d. Vary fitness routines and routes.
- e. Keep a low profile—do not flash large sums of money.
- f. Avoid taking liberty alone (use the buddy plan).
- g. Avoid unsafe areas (keep to well-populated districts).
- h. Check up and down streets for suspicious cars or individuals before departing.

#### 3. Transportation.

- a. Vary mode of transport if possible.
- b. Always lock the car, even in a locked garage.
- c. Vary times and stops if using bus, train, or subway.

- d. Check under and around car before getting in.
- e. Vary route/times to destinations.
- f. Use unmarked vehicles if possible.
- g. Never pick up hitchhikers.
- h. Avoid isolated or back streets and roads.

#### **4. Mail and Parcels.**

Be aware of the following letter and parcel bomb indicators:



- | Is the postmark or sender unknown?
- | Is the handwriting of foreign style?
- | Is the balance of the package unusual?
- | Is the letter too heavy for its size?
- | Are there protruding wires?
- | Does it have grease stains or an unusual smell?
- | Does it contain more postage stamps than necessary?





If any of the above indicators are encountered, do not touch! Call an explosive ordnance disposal expert.





## Appendix O

















### Common Military Symbology

#### 1. Basic Military Symbols.

Positions	
Battle	
Supplementary	
Strong point	

Frames	
Unit	
Command post	
Observation post	
Logistical/Medical	
Enemy unit	





Unit Sizes			
Fire team		Battalion	
Squad		Regiment	
Section		Brigade	X
Platoon		Division	X X
Company		MEF/Corps	X X X



<b>Unit Types</b>			
Infantry		Artillery	
Armor		Assault amphibious	
Light armor		Reconnaissance	
Mechanized infantry		Antitank	
Engineer		Motor transport	
Supply		Air defense	
Medical		Communications	
Maintenance		Electronic warfare	

<b>Wire</b>	
Unspecified	<b>X X X X X X X X</b>
Double apron fence	<b><del>X X X X X X X X</del></b>
Single concertina	<b><u>o o o o o o o o</u></b>

Weapons			
	Light	Medium	Heavy
Air defense gun			
Surface-to-air missile			
AT missile			
AT rocket			
AT gun			
Machine gun			
Mortar			
Howitzer			







Mines			
AP		AT	
Claymore			









<b>Armored Vehicles</b>	
Cavalry vehicle	
AAV	
APC	
LAV	

<b>Armored Vehicles (Tanks)</b>	
Light	
Medium	
Heavy	

**2. Control Measures.**

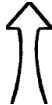

<b>Lines</b>			
Probable line of deployment	PLD-----PLD	Line of contact	
Line of departure	LD———LD (dtg) (dtg)	Phase line	PL Red———Red PL
Limit of advance	LOA———LOA	Lateral boundary	—    —

Points			
Contact point		Linkup point	
Coordinating point		Rally point	 RP
Check point		Passage point	

Maneuvers			
Attack position		Axis of advance	
Main effort		Air axis of advance	
Support attack		Ambush	
Objective		Direction of attack	

**3. Fire Support Coordination Measures.**



<b>Fire Lines</b>	
Coordinated fire line	CFL (est HQ) (est HQ) CFL ----- DTG eff DTG eff
Fire support coordination line	FSCL (est HQ) (est HQ) FSCL ----- DTG eff DTG eff
Restrictive fire line	RFL (est HQ) (est HQ) RFL ----- DTG eff DTG eff

<b>Fire Areas</b>	
Free-fire area	
No-fire area	
Restrictive fire area	

<b>Airspace Coordination Area</b>
<b>ACA (EST HQ)</b> <b>Min Alt/Max Alt (in Feet)</b> <b>DTG eff</b>

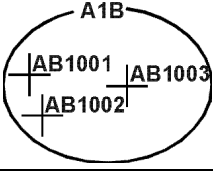
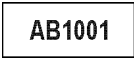
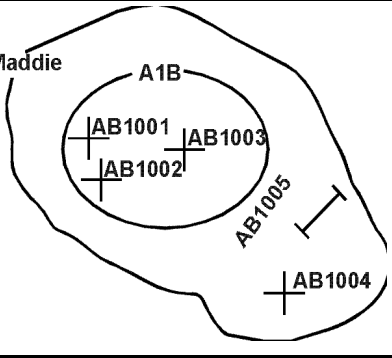
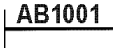

## Targets



Circular		Group of targets	
Rectangular		Series of targets	
Linear			
Point			

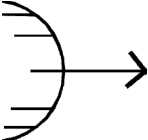
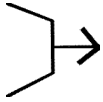
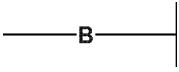

## Appendix P

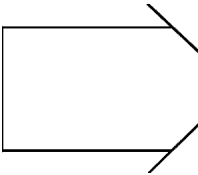
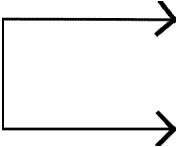
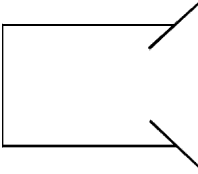
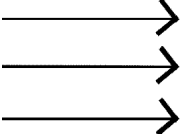
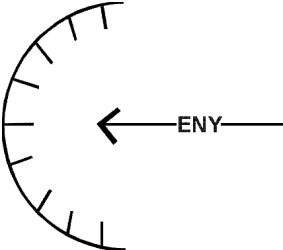
### Common Tactical Terms, Definitions, and Symbols

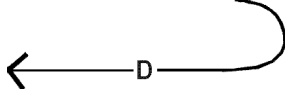

<p><b>Ambush.</b> A surprise attack by fire from concealed positions on a moving or temporarily halted enemy.</p>	
<p><b>Attack by fire.</b> Fires employed to destroy the enemy from a distance, normally used when the mission does not dictate or support occupation of the objective. This task is usually given to the supporting element during the offensive and as a counterattack option for the reserve during defensive operations. An attack by fire is not done in conjunction with a maneuvering force.</p>	
<p><b>Block.</b> 1. A tactical task assigned to a unit which requires it to deny the enemy access to a given area or to prevent enemy advance in a given direction or an avenue of approach. It may be for a specified time. Units assigned this mission may have to retain terrain and accept decisive engagement. 2. An obstacle effect that integrates fire planning and obstacle effort to stop an attacker on a specific avenue of approach or to prevent an enemy from exiting an engagement area.</p>	

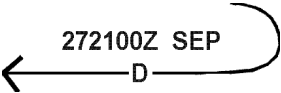
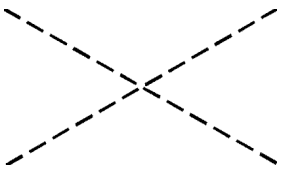
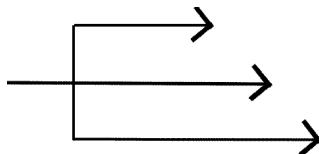

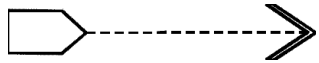
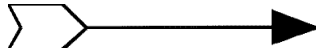
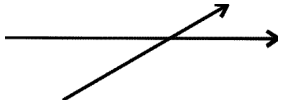
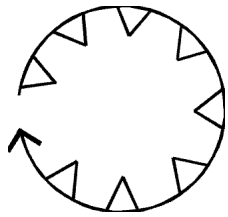
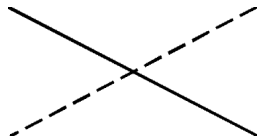

<p><b>Breach.</b> A tactical task where any means available are employed to break through or secure a passage through an enemy defense, obstacle, minefield, or fortification.</p>	
<p><b>Bypass.</b> A tactical task which involves maneuvering around an obstacle, position, or enemy force to maintain the momentum of advance. Bypassed obstacles and enemy forces are reported to higher headquarters.</p>	
<p><b>Canalize.</b> A tactical task used to restrict operations to a narrow zone by the use of obstacles, fires, and/or unit maneuvering or positioning.</p>	
<p><b>Clear.</b> A tactical task to remove all enemy forces from specific location, area, or zone.</p>	
<p><b>Contain.</b> A tactical task to restrict enemy movement.</p>	

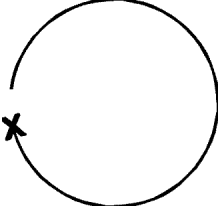
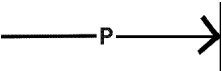
<p><b>Counterattack (axis is always dashed).</b> A form of offensive operation in which an attack by a part or all of a defending force is made against an enemy attacking force, for such specific purposes as regaining ground lost, cutting off or destroying lead enemy units, and with the general objective of regaining the initiative and denying the enemy the attainment of his goal or purpose in attacking.</p>	
<p><b>Counterattack by fire.</b> Fires employed to destroy the enemy from a distance, normally used when the mission does not dictate or support occupation of the objective. This task is usually given to the supporting element during the offensive and as a counterattack option for the reserve during defensive operations. An attack by fire is not done in conjunction with a maneuvering force.</p>	
<p><b>Delay.</b> Usually conducted when the commander needs time to concentrate, preserve, or withdraw forces; to establish defenses in greater depth; to economize in an area; to cover a defending or withdrawing unit; to protect a friendly unit's flank; or to complete offensive actions elsewhere. In the delay, the destruction of the enemy force is secondary to slowing his advance to gain time.</p>	

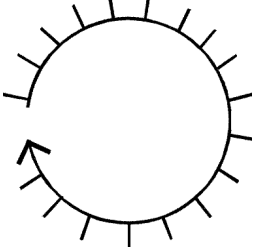
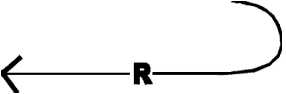
<p><b>Delay (until specified time).</b> Usually conducted when the commander needs time to concentrate, preserve, or withdraw forces; to establish defenses in greater depth; to economize in an area; to cover a defending or withdrawing unit; to protect a friendly unit's flank; or to complete offensive actions elsewhere. In the delay, the destruction of the enemy force is secondary to slowing his advance to gain time.</p>	
<p><b>Destroy.</b> A tactical task to physically render an enemy force combat-ineffective unless it is reconstituted.</p>	
<p><b>Disrupt.</b> A tactical task or obstacle effect that integrates fire planning and obstacle effort to break apart an enemy's formation and tempo, interrupt the enemy's timetable, cause premature commitment of enemy forces, and/or the piecemealing of his attack.</p>	
<p><b>Fix.</b> 1. A tactical task in which actions are taken to prevent the enemy from moving any part of his forces either from a specified location or for a specific period of time by holding or surrounding them to prevent their withdrawal for use elsewhere. 2. A tactical obstacle effect that integrates fire planning and obstacle effort to slow an attacker within a specified area—normally an engagement area.</p>	

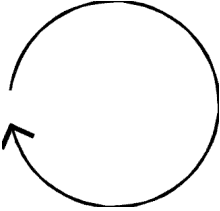
<p><b>Follow and assume.</b> An operation in which a committed force follows a force conducting an offensive operation and is prepared to continue the mission of the force it is following when that force is fixed, attrited, or otherwise unable to continue. Such a force is not a reserve, but is committed to accomplish specified tasks.</p>	
<p><b>Follow and support.</b> An operation in which a committed force follows and supports the mission accomplishment of a force conducting an offensive operation. Such a force is not in a reserve, but is committed to accomplish specified tasks.</p>	
<p><b>Interdict.</b> A tactical task which is oriented on the enemy to prevent, hinder, or delay the use of an area or route by enemy forces.</p>	
<p><b>Isolate.</b> A tactical task given to a unit to seal off (both physically and psychologically) an enemy from its sources of support, to deny an enemy freedom of movement, and prevent an enemy unit from having contact with other enemy forces. An enemy must not be allowed sanctuary within its present position.</p>	
<p><b>Neutralize.</b> To render enemy personnel or material incapable of interfering with a particular operation.</p>	

<p><b>Occupy.</b> A tactical task in which a force moves onto an objective, key terrain, or other manmade or natural terrain area without opposition and controls that entire area.</p>	
<p><b>Penetrate.</b> The breaking through of the enemy's defense and disrupting the defensive system.</p>	
<p><b>Relief in place.</b> An operation in which, by direction of higher authority, all or part of a unit is replaced in an area by the incoming unit. The responsibilities of the replaced elements for the mission and the assigned zone of operations are transferred to the incoming unit. The incoming unit continues the operation as ordered.</p>	
<p><b>Retain.</b> A tactical task to occupy and hold a terrain feature to ensure it is free of enemy occupation or use.</p>	
<p><b>Retirement.</b> A form of retrograde operation; a directed, rearward movement by a force that is not in contact with the enemy and does not anticipate significant contact with the enemy.</p>	

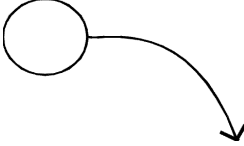
<p><b>Secure.</b> A tactical task to gain possession of a position or terrain feature, with or without force, and to deploy in a manner which prevents its destruction or loss to enemy action. The attacking force may or may not have to physically occupy the area.</p>	
<p><b>Security.</b> A task to maintain surveillance; provide early warning to the main body; or impede, destroy, and harass enemy reconnaissance within its capability.</p>	
<p><b>Guard.</b> A form of security operation whose primary task is to protect the main force by fighting to gain time, while also observing and reporting information, to prevent enemy ground observation of and direct fire against the main body by reconnoitering, attacking, defending, and delaying. A guard force normally operates within the range of the main body's indirect fire weapons.</p>	
<p><b>Cover.</b> Shelter or protection from enemy observation that reduces the effects of enemy direct and indirect fire.</p>	
<p><b>Seize.</b> A tactical task to clear a designated area and obtain control of it.</p>	

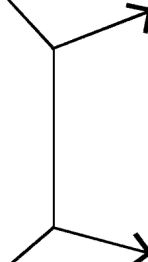
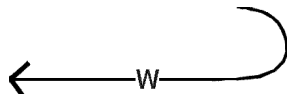
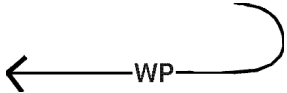

<p><b>Support by fire.</b> A tactical task by which a maneuver element moves to a position on the battlefield where it can engage the enemy by direct fire to support a maneuvering force by either support by fire by overwatching or by establishing a base of fire.</p>	 A diagram illustrating support by fire. It shows a central vertical line with two diagonal lines extending from its top and bottom ends. From the top-right end of the top diagonal line, an arrow points up and to the right. From the bottom-right end of the bottom diagonal line, an arrow points down and to the right.
<p><b>Withdrawal.</b> A type of retrograde where a force in contact plans to disengage from the enemy and move in a direction away from the enemy.</p>	 A diagram illustrating withdrawal. It shows a horizontal line with an arrow pointing to the left. The letter 'W' is placed below the line. At the right end of the line, there is a curved arrow pointing back to the left, indicating a disengagement.
<p><b>Withdrawal under pressure.</b> A type of retrograde where a force disengages and moves directly away from the enemy while the enemy is attacking.</p>	 A diagram illustrating withdrawal under pressure. It shows a horizontal line with an arrow pointing to the left. The letters 'WP' are placed below the line. At the right end of the line, there is a curved arrow pointing back to the left, indicating a disengagement while under pressure.

## Appendix Q

### Metric Conversion Charts

#### 1. Conversion Chart.

<b>Multiply</b>	<b>By</b>	<b>To Obtain</b>
Centimeters	.03281	Feet
Centimeters	.3937	Inches
Cubic feet	.02832	Cubic meters
Cubic meters	35.31	Cubic feet
Degrees	60.00	Minutes (circle)
Feet	30.48	Centimeters
Feet	.3048	Meters
Feet per minute	.01136	Miles per hour
Feet per second	.6818	Miles per hour
Gallons (U.K.)	1.201	Gallons (U.S.)
Gallons (U.S.)	.8327	Gallons (U.K.)
Inches	2.540	Centimeters
Inches	.08333	Feet
Inches	1000.00	Miles
Kilometers	.6214	Miles
Meters	100.00	Centimeters
Meters	3.281	Feet
Meters	39.37	Inches
Meters	1.094	Yards
Miles	5280.00	Feet
Miles	1.609	Kilometers

<b>Multiply</b>	<b>By</b>	<b>To Obtain</b>
Mils	.001	Inches
Square meter	10.76	Square feet
Square meter	1.196	Square yards
Square miles	2.590	Square kilometers
Square yards	0.8361	Square meters
Temperature (C) + 17.8	1.80	Temperature (F)
Temperature (F) -32	.5556	Temperature (C)
Yards	.9144	Meters

**2. Meters to Feet or Miles.**

<b>Meters</b>	<b>Feet</b>	<b>Miles</b>
1	3.281	
50	164.043	
100	328.087	
200	656.10	0.12
300	984.30	0.19
400	1312.30	0.25
500	1640.40	0.31
1000	3280.90	0.62
2000	6561.7	1.24
3000	9842.60	1.86
4000	13123.50	2.49
5000	16404.3	3.11
6000	19686	3.73

<b>Meters</b>	<b>Feet</b>	<b>Miles</b>
7000	22967	4.35
8000	26248	4.97
9000	29529	5.59
10000	32810	6.21

## Appendix R

### Glossary

#### Section I. Abbreviations and Acronyms

A&S	assault and security
AA	antiaircraft
ADAM	artillery delivered area munitions
ALICE	all-purpose lightweight individual carrying equipment
APC	armored personnel carrier
APDS	armor-piercing discarding sabot
APERS	antipersonnel
AP-I	armor piercing, incendiary
APL	assistant patrol leader
aslt	assault
AT	antitank
ATGM	antitank guided missile
BAMCIS	begin planning, arrange for reconnaissance, make reconnaissance, complete the plan, issue the order, and supervise
BD	base detonating
BP	battle position
C <sup>2</sup>	command and control
CAS	close air support
CLGP	cannon launched guided projectile
co.	company
COF	conduct of fire
CP	command post

CS	O-chlorobenzylidene malononitrile
CSAR	combat search and rescue
CVT	controlled variable time
D	delay
DOS	Department of State
DRAW-D	defend, reinforce, attack, withdraw, delay
E&E	evasion and escape
EA	engagement area
EFST	essential fire support tasks
EPW	enemy prisoner of war
FAC	forward air controller
FDC	fire direction center
FDO	fire direction officer
FFA	free-fire area
FFE	fire for effect
FH	frequency hopping
FH-M	frequency hopping master
FM	frequency modulation
FO	forward observer
FPF	final protective fire
FPL	final protective line
FPP	final preparation position
FSC	fire support coordinator
FSCC	fire support coordination center
FSCM	fire support coordinating measure
FSEM	fire support execution matrix
FSP	fire support plan
FUC	forward unit commander



KOCSA-W . . . . . key terrain, observation and fields of fire, cover  
and concealment, obstacles and avenues  
of approach, weather/astrological data

ldr . . . . . leader  
LOA . . . . . limit of advance  
LP . . . . . listening post  
LZ . . . . . landing zone

m . . . . . meter  
MAGTF . . . . . Marine air-ground task force  
MCRP . . . . . Marine Corps reference publication  
mech . . . . . mechanized  
METT-T . . . . . mission, enemy, terrain and weather, troops and  
support available-time available

MG . . . . . machine gun  
MHz . . . . . megahertz  
MIJI. . . . . meaconing, intrusion, jamming, interference  
mm . . . . . millimeter  
MOOTW . . . . . military operations other than war  
MOPP . . . . . mission-oriented protective posture  
MOUT . . . . . military operations on urbanized terrain  
MRE . . . . . meal, ready-to-eat  
MT . . . . . mechanical time  
MTO . . . . . message to observer

NATO . . . . . North Atlantic Treaty Organization  
NEO . . . . . noncombatant evacuation operation  
NGF . . . . . naval gunfire

obj . . . . . objective



OP . . . . . observation post  
 OPS . . . . . operations  
 ORP . . . . . objective rally point  
 OT . . . . . observer to target  
  
 PAX . . . . . passengers  
 PD . . . . . point detonation  
 PHIB . . . . . amphibious  
 PIR . . . . . priority intelligence requirement  
 PLD . . . . . probable line of deployment  
 POD . . . . . point of departure  
 POL . . . . . petroleum, oils, and lubricants  
 POR . . . . . point of return  
 PSYOP . . . . . psychological operations  
 pyro . . . . . pyrotechnics  
 PZCO . . . . . pick-up zone control officer  
  
 Q . . . . . quick  
  
 RAAMS . . . . . remote antiarmor mine system  
 recon . . . . . reconnaissance  
 RF . . . . . radio frequency  
 ROE . . . . . rules of engagement  
 RP . . . . . release point  
 RPG . . . . . rocket propelled grenade  
  
 SAFE . . . . . security, automatic weapon, fields of fire, entrench  
 SALUTE . . . . . size, activity, location, unit, time, equipment  
 SAR . . . . . search and rescue  
 SC . . . . . single channel  
 SEAD . . . . . suppression of enemy air defenses

SFCP	shore fire control party
SMK	smoke
SOP	standing operating procedure
sqd.	squad
tac	tactical
TACP	tactical air control party
TAD	tactical air direction
TAR	tactical air request
Ti	mechanical time
TOT	time on target
TOW	tube launched, optically tracked, wire command link, guided missile
TP	training practice
TRAP	tactical recovery of aircraft and personnel
TRP	target reference point
TTT	time to target
UHF	ultrahigh frequency
UTM	universal traverse mercator
VDC	volts direct current
VHF	very high frequency
VT	variable time
VX	O-ethyl methyl phosphonothiolate (a V-agent)
WC	white, concentrated
WP	white phosphorus
WSP	white star parachute
ZIPPO	zone inspection, planning, preparing and operation

## Section II. Definitions

### A

**alternate position**—The position given to a weapon, unit, or individual to be occupied when the primary position becomes untenable or unsuitable for carrying out its task. The alternate position is so located that the weapon can fulfill its original task. (FMFRP 0-14)

**ambush**—A surprise attack by fire from concealed positions on a moving or temporarily halted enemy. (FMFRP 0-14)

**assault position**—That position between the line of departure and the objective in an attack from which forces assault the objective. Ideally, it is the last covered and concealed position before reaching the objective (primarily used by dismounted infantry). (FMFRP 0-14)

**automatic rifleman**—A fire team member responsible for the effective employment of the automatic rifle and for the condition and care of his equipment. (FMFRP 0-14)

### B

**battle position**—A defensive location oriented on the most likely enemy avenue of approach from which a unit may defend or attack.

Such units can be as large as reinforced battalions and as small as platoons. The unit assigned to the battle position is located within the general outline of the battle position, but other forces may operate outside the battle position to provide early detection of enemy forces and all-round security. (FMFRP 0-14)

**bounding overwatch**—A tactical movement technique used when contact with enemy ground forces is expected. The unit moves in bounds. One element is in position to overwatch the other element's move. The overwatching element is always positioned to support the moving unit by fire or by fire and maneuver. This is the slowest but most secure movement technique. (FMFRP 0-14)

**breach**—The employment of any means available to break through or secure a passage through an enemy defense, obstacle, minefield, or fortification. (FMFRP 0-14)

**bypass**—Maneuvering around an obstacle, position, or enemy force to maintain the momentum of advance. Previously unreported obstacles are reported to higher headquarters. Bypassed enemy forces are reported to higher headquarters. (FMFRP 0-14)

## **C**

**clear enemy in zone**—A requirement to eliminate organized resistance in an assigned zone by destroying, capturing, or forcing the withdrawal of enemy forces that could interfere with the unit's ability to accomplish its mission. (FMFRP 0-14)

**combat operations center**—The primary operational agency required to control the tactical operations of a command that employs ground and aviation combat, combat support, and combat service support elements or portions thereof. The combat operations center continually monitors, records, and supervises operations in the name of the commander and includes the necessary personnel and communications to do the same. (FMFRP 0-14)

**combined arms**—The tactics, techniques, and procedures employed by a force to integrate firepower and mobility to produce a desired effect upon the enemy. (FMFRP 0-14)

**coordinated fire line**—A line beyond which conventional surface fire support means (mortars, field artillery, and naval gunfire ships) may fire at any time within the zone of the establishing headquarters without additional coordination. (FMFRP 0-14)

**counterinsurgency**—Those military, paramilitary, political, economic, psychological, and civic actions taken by a government to defeat insurgency. (Joint Pub 1-02)

## D

**delaying action**—A type of retrograde operation in which space is traded for time, and maximum punishment is inflicted on the enemy without accepting decisive engagement, penetration, or being bypassed. (FMFRP 0-14)

**delaying operation**—An operation in which a force under pressure trades space for time by slowing down the enemy's momentum and inflicting maximum damage on the enemy without, in principle, becoming decisively engaged. (Joint Pub 1-02)

## E

**emergency action plan (EAP)**—State Department generated and maintained set of documents to assist emergency actions at a particular post. The post's evacuation plan is a portion of this set of documents. Contains information on assembly areas, evacuation sites, key personnel, phone numbers, radio keys, evacuation routes, and number of United States citizens, etc.

**evacuation control center (ECC) site**—Planned site for the administrative processing of noncombatants, usually collocated with the assembly area for evacuees.

**evacuation site**—Planned site for the assembly and embarkation of noncombatants during a NEO.

## F

**final coordination line**—A line used to coordinate the ceasing and shifting of supporting fires and the final deployment of the assault echelon in preparation for launching an assault against an enemy position. (FMFRP 0-14)

**final protective line**—A line selected where an enemy assault is to be checked by interlocking fire from all available weapons. A final protective line may be parallel with, or oblique to, the front of the position. (FMFRP 0-14)

**fire and maneuver**—The process of one or more elements establishing a base of fire to engage the enemy, while the other element(s) maneuver to an advantageous position from which to close with and destroy or capture the enemy. (FMFRP 0-14)

**fire and movement**—A technique primarily used in the assault wherein a unit or element advances by bounds or rushes, with subelements alternately moving and providing covering fire for other moving subelements. Fire and movement may be done by individuals (personnel or vehicles) or units (such as fire teams or squads). Usually, fire and movement are used only when under effective fire from the enemy because it is relatively slow and difficult to control. (FMFRP 0-14)

**fire support**—Assistance to elements of the Marine air-ground task force engaged with the enemy rendered by other firing units, including (but not limited to) artillery, mortars, naval surface fire support, and offensive air support. (FMFRP 0-14)

**fire support coordinator**—The officer in charge of the fire support coordination center. He is the direct representative of the landing force commander for the planning and coordination of all available fire support. (FMFRP 0-14)

**forward air controller**—An officer (aviator/pilot) member of the tactical air control party who, from a forward ground or airborne position, controls aircraft in close air support of ground troops. In the Marine Corps, a forward air controller is a naval aviator or naval flight officer, within the tactical air control party, who is specifically trained and qualified to exercise control, from the ground, of air support of ground forces. (FMFRP 0-14)

**free-fire area**—A specifically designated area into which any weapons system may be fired without any additional coordination. (FMFRP 0-14)

**frontage**—The width of the front plus that distance beyond the flanks covered by observation and fire by a unit in combat. (FMFRP 0-14)

**frontal attack**—An offensive maneuver in which the main action is directed against the front of the enemy forces and over the most direct approaches. (FMFRP 0-14)

## **H**

**hack**—The command to begin timing or synchronize time. (FMFRP 0-14)

**helicopterborne operation**—A military action in which combat forces and their equipment maneuver about the battlefield by helicopters or vertical-landed aircraft. Aviation activities are under the



control of the aviation combat element commander who is assigned in direct or general support of one or more combat element(s). (FMFRP 0-14)

## L

**lane**—A clear route through an obstacle. A lane for foot troops is a minimum of one meter in width and may be further expanded. A foot lane is marked with tracing tape along its center line. A single lane for vehicles is a minimum of eight meters in width; a double lane is at least 15 meters in width. Vehicle lanes are marked by any means available. (FMFRP 0-14)

**linkup**—An operation wherein two friendly ground forces join together in a hostile area. (FMFRP 0-14)

**local security**—Those security elements established in the proximity of a unit to prevent surprise by the enemy. (FMFRP 0-14)

## M

**mechanized operations**—Tactical operations designed to maximize the ground mobility, protection, shock action, and firepower of combat vehicles to concentrate combat power rapidly against the enemy. Combat power is generated by the massed employment of tanks and by enhancing the mobility of the forces through the use of assault amphibious vehicles and other ground mobility means. (FMFRP 0-14)

**mission-oriented protective posture**—A flexible system for protection against a chemical attack devised to maximize the unit's ability to accomplish its mission in a toxic environment. This posture permits maximum protection from chemical agent attack without unacceptable reduction in efficiency. (FMFRP 0-14)

## N

**no-fire area**—A designated area into which neither fires nor effects of fires will occur. Two exceptions occur: (a) the establishing headquarters asks for or approves fire or (b) an enemy force takes refuge in the area, poses a major threat, and there is insufficient time to clear the fires needed to defend the friendly force. (FMFRP 0-14)

## O

**obstacle**—Any obstruction designed or employed to disrupt, fix, turn, or block the movement of an opposing force, and to impose additional losses in personnel, time, and equipment on the opposing force. Obstacles can exist naturally or can be manmade, or can be a combination of both. (Joint Pub 1-02) The effectiveness of an obstacle is enhanced considerably when covered by observation and fire. Obstacles can include abatis, antitank ditches, blown bridges, built-up areas, minefields, rivers, road craters, terrain, and wire. (FMFRP 0-14)

**overhead fire**—Fires delivered over the heads of friendly troops. (FMFRP 0-14)

**overwatch**—1. A tactical technique in which one element is positioned to support the movement of another element with immediate fire. 2. The tactical role of an element positioned to support the movement of another element with immediate fire. (FMFRP 0-14)

## P

**point of departure**—A specific place where a unit will cross the line of departure. (FMFRP 0-14)

**position**—1. A location or area occupied by a military unit. 2. The location of a weapon, unit, or individual from which fire is delivered upon a target. (FMFRP 0-14)

- a. **primary position**—A position which provides the best means to accomplish the assigned mission.
- b. **alternate position**—A position to be occupied when the primary position becomes untenable or unsuitable for carrying out its task. The alternate position is located so that the individual can continue to fulfill his original task.
- c. **supplementary position**—A position which provides the best means to accomplish a task that cannot be accomplished from the primary or alternate position. (FMFRP 0-14)

**principal direction of fire**—The direction of fire assigned or designated as the main direction in which a weapon will be oriented. It is selected based on the enemy, mission, terrain, and weapons' capability. (FMFRP 0-14)

**priority of fire**—Guidance to a fire support planner to organize and employ fire support means in accordance with the relative importance of the maneuver unit's missions. (FMFRP 0-14)

**probable line of deployment**—An easily recognized line selected on the ground where attacking units deploy in line formation prior to beginning a night attack. (FMFRP 0-14)

**protective wire**—Barbed wire entanglements located to prevent surprise assaults from points close to the defensive positions. They are close enough to be observed day and night and far enough from friendly positions to keep the enemy beyond normal hand grenade range. Protective wire is normally positioned from 50 to 75 meters from friendly positions. (FMFRP 0-14)

**pursuit by fire**—When the assault through the assigned objective is completed, the squad fires upon withdrawing enemy forces until they are no longer visible or are beyond effective range. (FMFRP 0-14)

## R

**rally point**—An easily identifiable point on the ground at which units can reassemble and reorganize if they become dispersed. (FMFRP 0-14)

**rear area security**—The measures taken before, during, and/or after an enemy airborne attack, sabotage action, infiltration,

guerrilla action, and/or initiation of psychological or propaganda warfare to minimize the effects thereof. (FMFRP 0-14)

**restrictive fire area**—An area in which specific restrictions are imposed and into which fires that would exceed those restrictions will not be delivered without coordination with the establishing headquarters. The purpose of the restrictive fire area is to regulate fires into an area according to the stated restrictions. (FMFRP 0-14)

**restrictive fire line**—A line established between converging friendly forces that prohibits fires, or effects from fires, across the line without coordination with the affected force. The purpose of the restrictive fire line is to prevent interference between converging friendly forces. (FMFRP 0-14)

**route reconnaissance**—A directed effort to obtain detailed information of a specified route and all terrain from which the enemy could influence movement along that route. (FMFRP 0-14)

**retirement**—An operation in which a force out of contact moves away from the enemy (Joint Pub 1-02).

**retrograde**—A type of operation in which a unit conducts a directed, organized movement to the rear or away from the enemy. Forms of retrograde include delay, withdrawal, and retirement (MCRP 5-2A).

## S

**seize**—To clear a designated area and obtain control of it. (FMFRP 0-14)

**successive positions**—Defensive fighting positions located one after another on the battlefield. A force can conduct a delaying action from successive delaying positions. (FMFRP 0-14)

**supporting arms**—Weapons systems of all types employed to provide fires to the commander. (FMFRP 0-14, proposed modification to Joint Pub 1-02)

## T

**tactical air control party**—A subordinate operational component of a tactical air control system designed to provide air liaison to land forces and for the control of aircraft. (Joint Pub 1-02) In the Marine Corps, tactical air control parties are organic to infantry divisions, regiments, and battalions. Tactical air control parties establish and maintain facilities for liaison and communications between parent units and airspace control agencies, inform and advise the ground unit commander on the employment of supporting aircraft, and request and control air support. (FMFRP 0-14)

**tactical recovery of aircraft and personnel**—A mission performed by an assigned and briefed aircrew for the specific purpose

of the recovery of personnel, equipment, and/or aircraft when the tactical situation precludes search and rescue assets from responding and when survivors and their location have been confirmed. (FMFRP 0-14)

**target precedence list**—The commander’s list of types of mobile potential targets arranged in the order in which they are to be attacked. It establishes target priorities for reactive targeting. (FMFRP 0-14)

**time on station**—The time that an aircraft can actually spend performing its assigned mission. It does not include the time transiting to and from the operating site. (FMFRP 0-14)

**time to target**—The number of minutes and seconds to elapse before ordnance impacts on target. (FMFRP 0-14)

**traveling overwatch**—A movement technique used when contact with enemy forces is possible. The lead element and trailing element are separated by a short distance which varies with the terrain. The trailing element moves at variable speeds and may pause for short periods to overwatch the lead element. It keys its movement to terrain and the lead element. The trailing element overwatches at such a distance that should the enemy engage the lead element, it will not prevent the trailing element from firing or moving to support the lead element. (FMFRP 0-14)

## W

**withdrawal operation**—A planned operation in which a force in contact disengages from an enemy force (Joint Pub 1-02).